

Single Axis Robot

KKP series

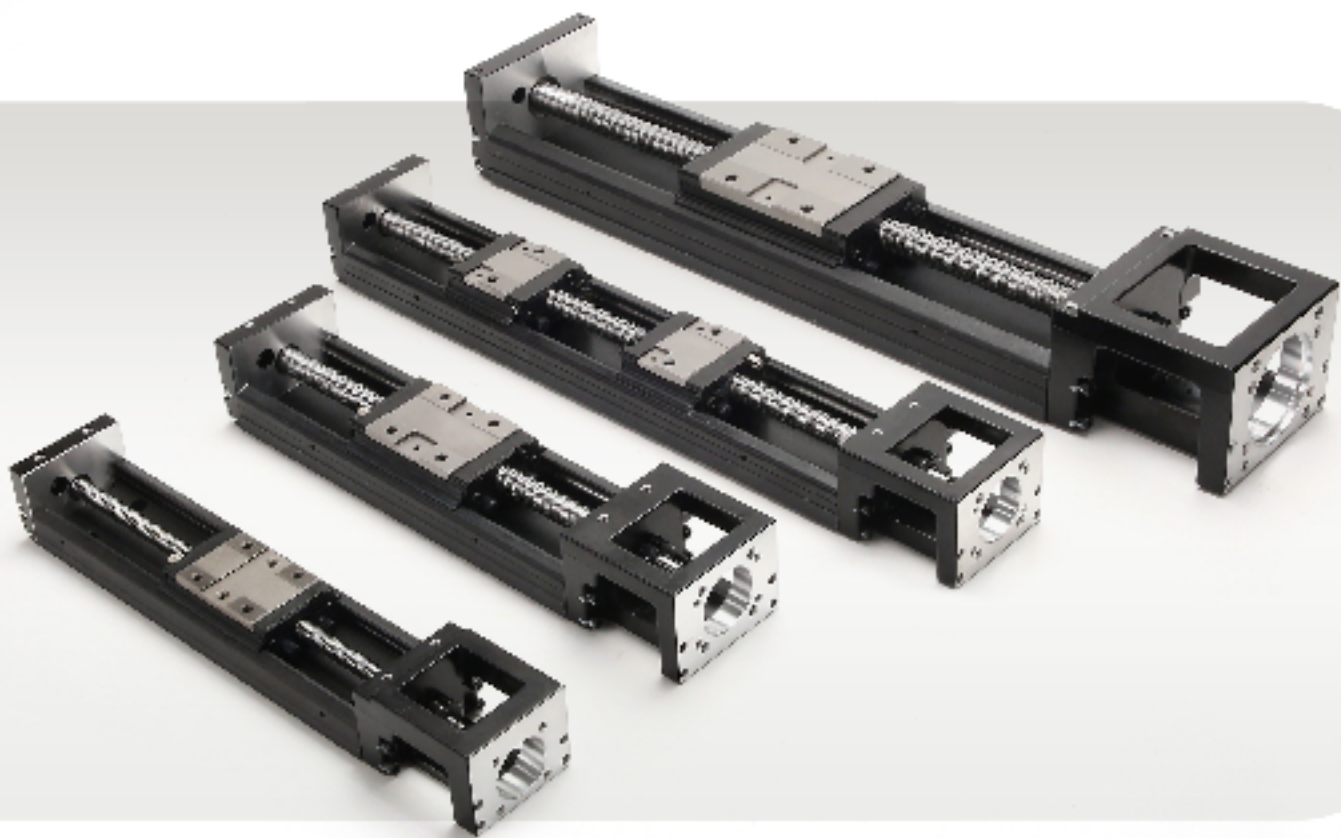

Linear Module

General Overview

Warning

Single Axis Robots have both electrical and mechanical components, for safety, please read and follow all of the related precautions before selection and use. ALM is not held responsible for any malfunctions, damages, or accidents caused by the misuse of the product.

Personal Safety

- Single Axis Robots are designed for industrial purposes only.
- During operation, the users should stay clear of the Single Axis Robots mechanical range of motion to avoid possible injury.
- When the motor power is ON, people with pacemakers should keep away at least one meter to avoid any disturbance.
- To prevent fires, Single Axis Robots should not be placed near the ignition of flammable gases.

Storage and Installation

- Avoid any possible collisions or dropping of the product.
- When storing, it is recommended that the product be well packed and laid down flat. Do not expose the product to hot, cold or humid conditions.
- Do not disassemble or modify the products to avoid possible malfunctions or accidents.
- During installation, ensure the product is fixed correctly to avoid any loosening caused by vibrations.
- Take care when selecting the correct coupling and motor hardware for installation and be aware of the alignment to the centerline of the shaft when tightening the screws. Do not force the install.

Operation

- The operation conditions need to be within the rated values as shown in the technical information.
- Avoid dust, debris and any foreign objects from entering the ball return system.
- Operational temperature should be under 80 °C. In high temperature environments above 80 °C, please contact ALM sales.
- Confirm first with ALM sales if the product can be used in a special environment, such as vacuum, vibration, clean room, corrosive chemicals, organic solvents, extreme high or low temperatures, humidity, liquid splashes, oil drops or mist, high salt, heavy load, vertical or cantilever installations.
- For vertical installations, when loaded, there is a possibility that the slider may fall. We recommend to adding proper braking and ensure functionality before operation.

Maintenance

- Lubricate the product before the initial use. Note the type of grease used and avoid mixing different types together.
- For normal operating conditions, it is recommended to check the operation every 100km, clean and supply grease onto the rail and shaft.

Linear Module

ALM KKP Single Axis Robot is driven by a ballscrew while a guideway slides on an optimized U-rail to achieve higher accuracy and greater stiffness.

Features

- An integrated system
- Easy installation and maintenance
- Compact and lightweight
- High accuracy
- High stiffness
- Complete line of accessories

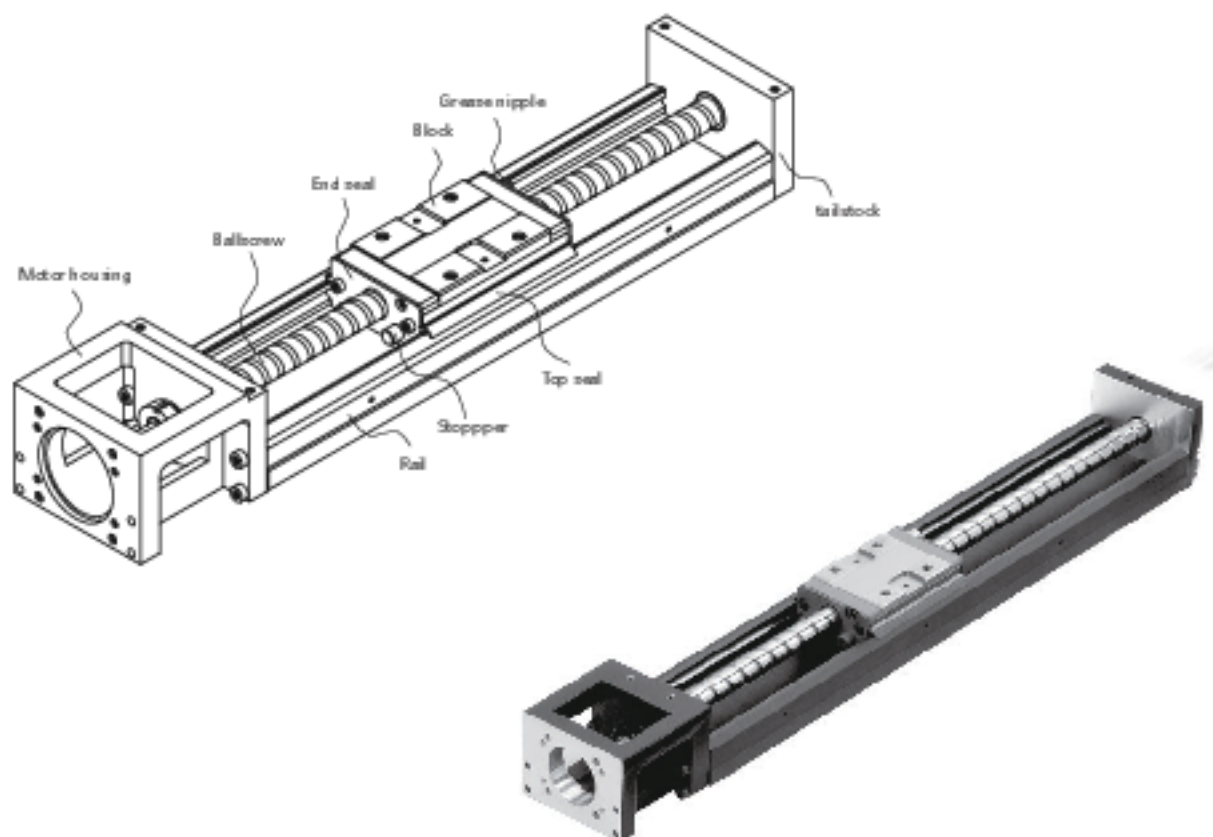
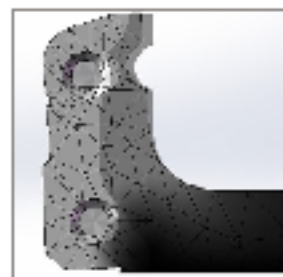
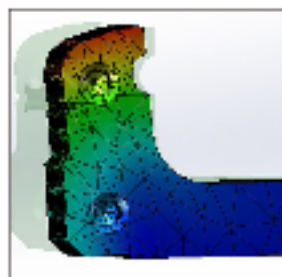

Linear Module

KKP

Modulization

The KKP Single Axis Robot integrating a ball screw and guideway forms a modularized product. The modularized design can help customers save time, cost and system inspection. Therefore, installation efficiency and a space-saving design are also promoted.

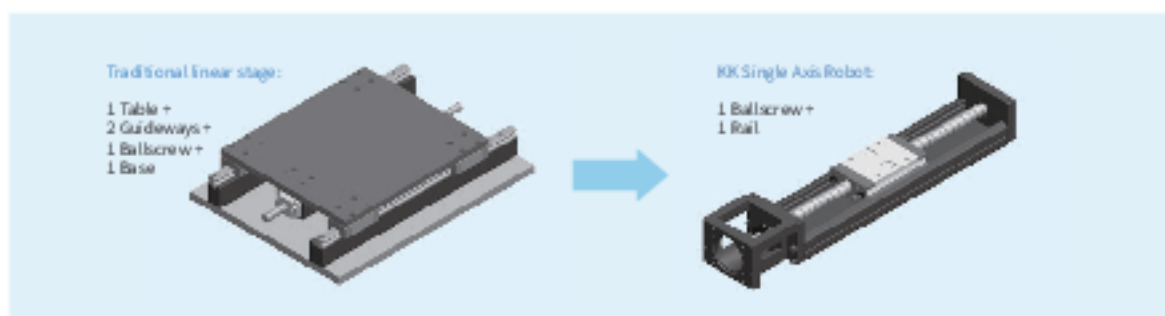

Equivalent Load

The gothic arch contact design sustains load from all directions and offers high rigidity and accuracy.

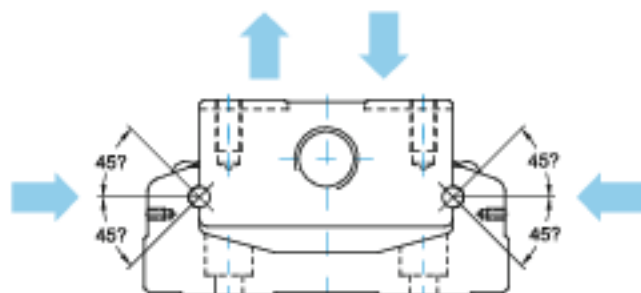

High Stiffness

Using finite element analysis on the U-shaped cross section allows the volume and rigidity to be made balanced, therefore, a high rigidity rail, compact design and a light weight design are also accomplished simultaneously.

Model no.	I_x	I_y
KKP40	3.533×10^3	5.317×10^4
KKP50	9.6×10^3	1.34×10^5
KKP60	2.056×10^4	2.802×10^5
KKP86	7.445×10^4	1.134×10^6
KKP100	1.296×10^5	2.035×10^6
KKP130	2.546×10^5	5.073×10^6

I_x : Moment of inertia computed about X axis
 I_y : Moment of inertia computed about Y axis

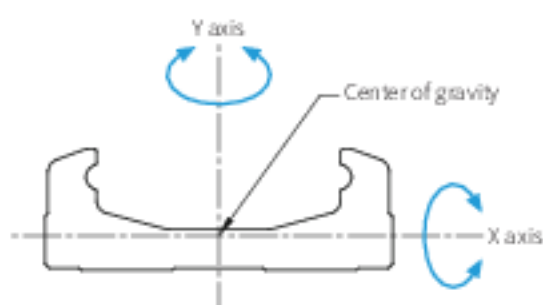

Various Specification

KKP Single Axis Robots of various specifications are developed, providing customers with different choices relating to space and loading conditions.

Model no.	W	H
KKP40	40	20
KKP50	50	26
KKP60	60	33
KKP86	86	46
KKP100	100	55
KKP130	130	65

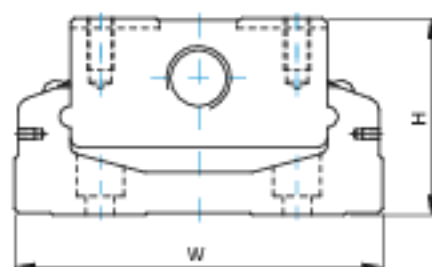

Linear Module

KKP

Accessories

Accessories of KKP Single Axis Robot are also supported for specific demands, such as an aluminum cover, bellows, motor adaptor flange and limit switches.

- Aluminum cover and bellows: contamination protection
- Motor adaptor flange: connection for different types of motors
- Limit switches: starting point, positioning and other safety matters

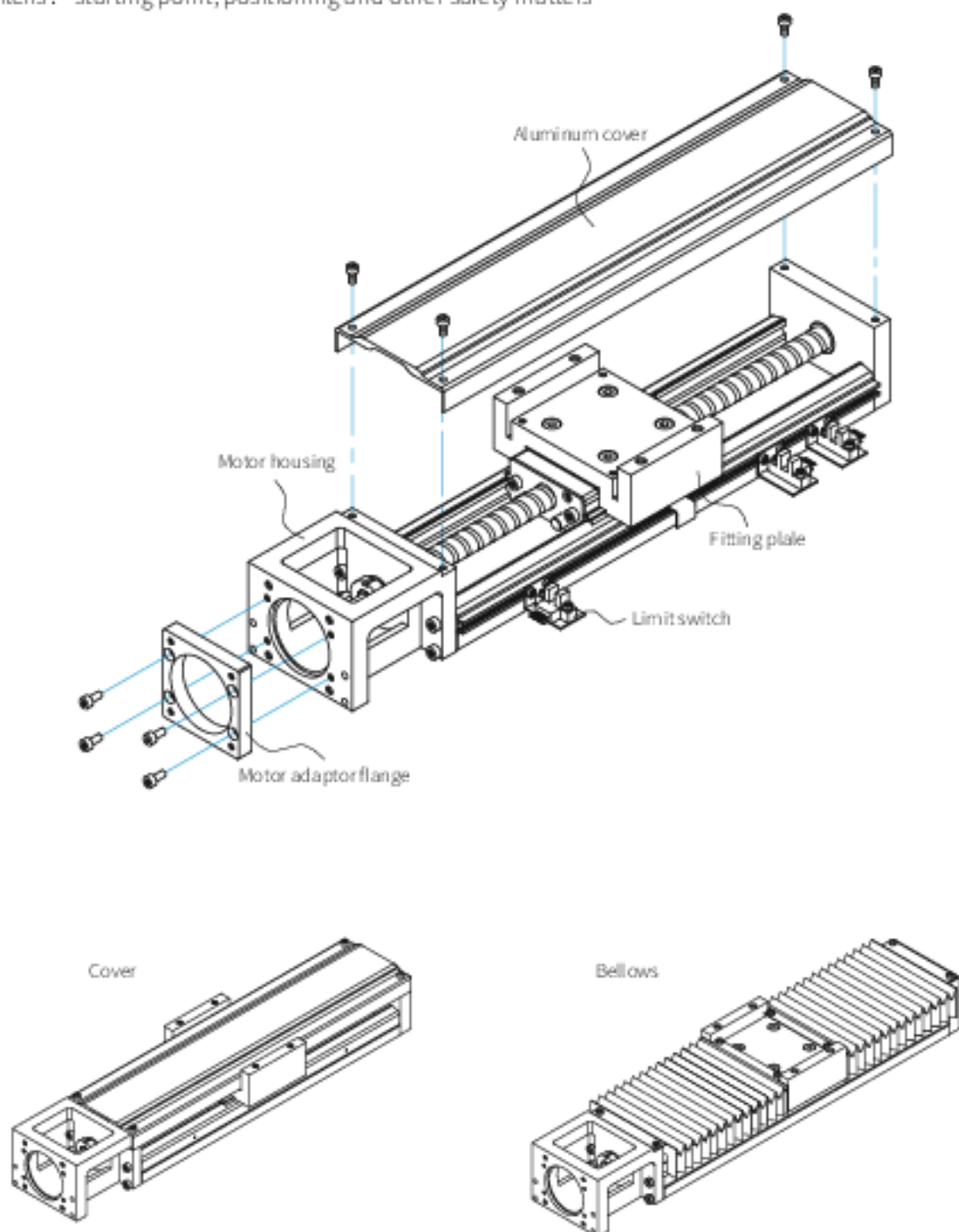

Linear Module

Model Number of KKP Series

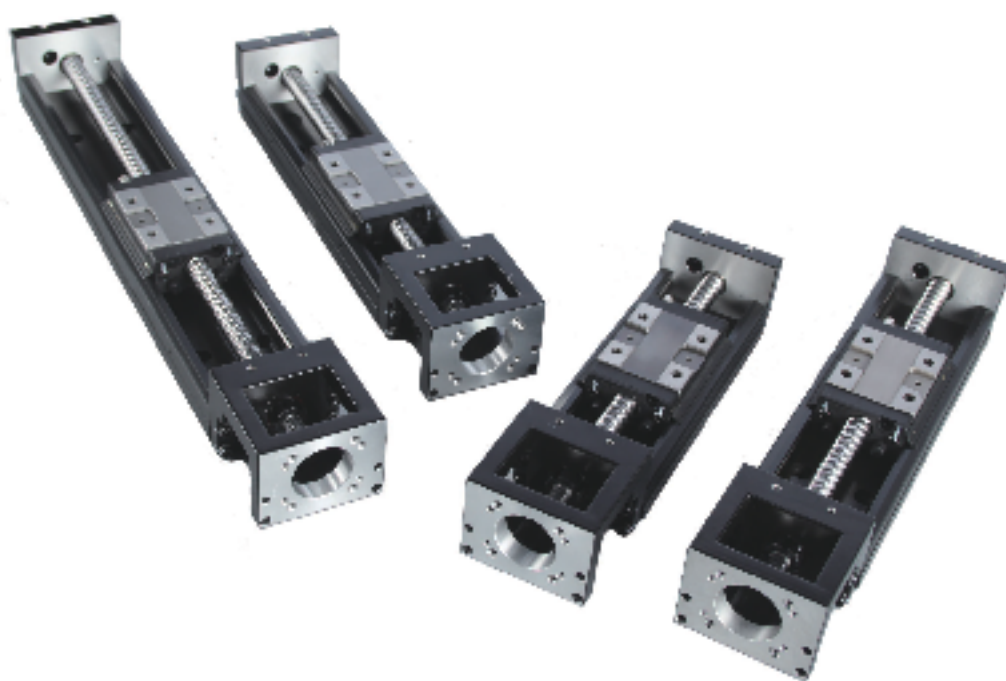
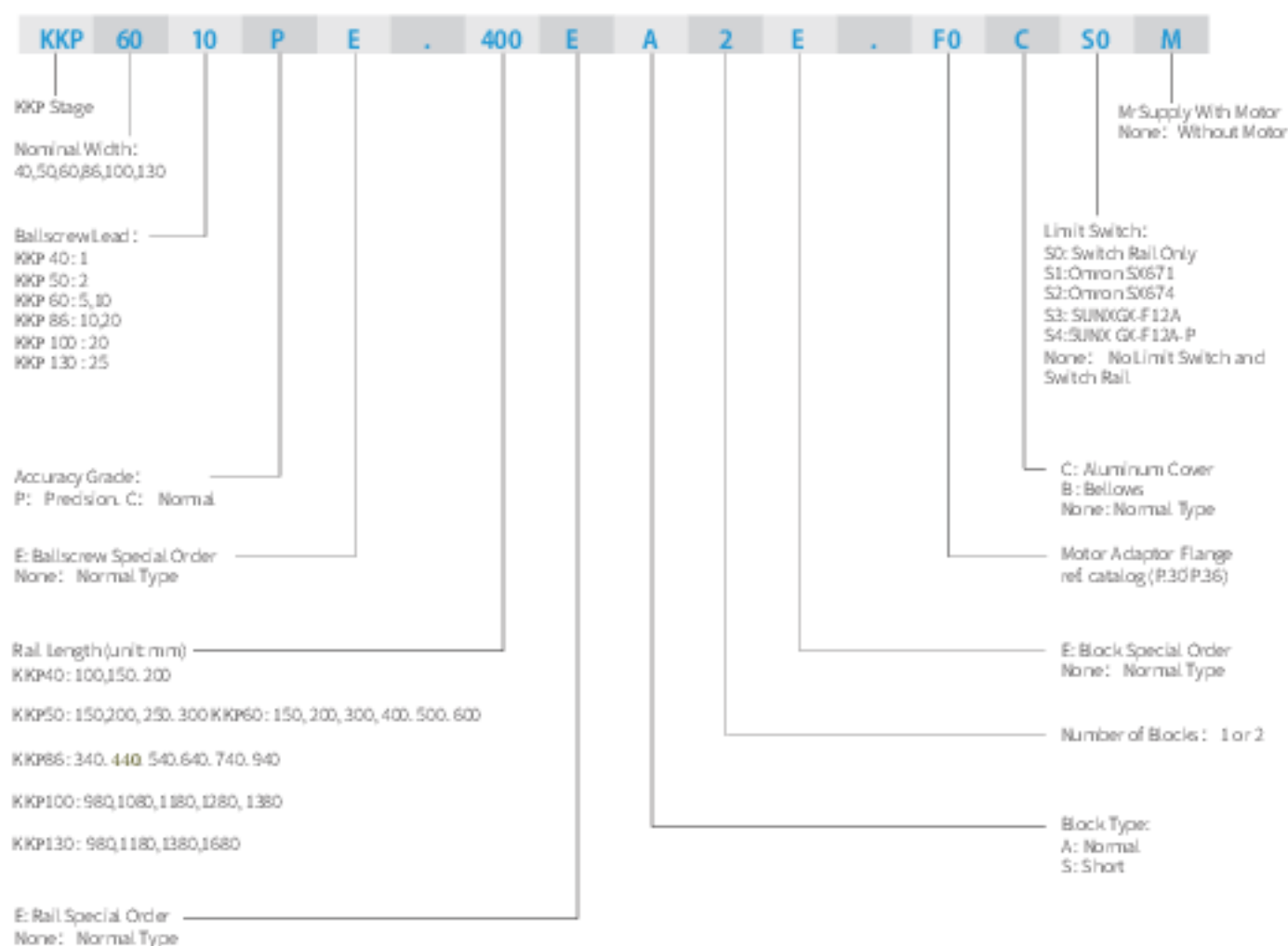

Linear Module

Specifications

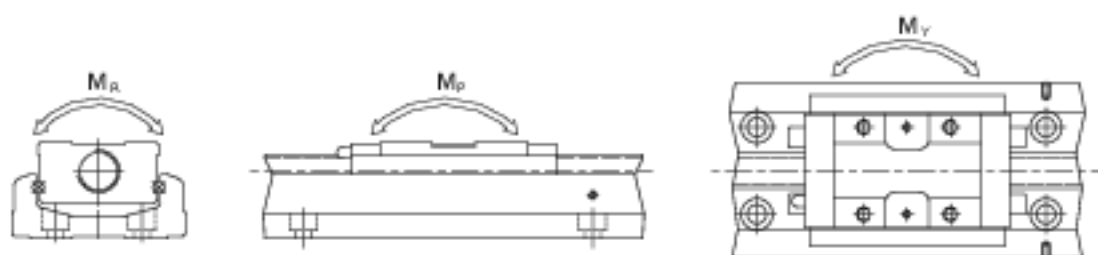

Model No.		Ball screw				Guideway															
		Nominal Diameter (mm)	Lead (mm)	Basic Dynamic Load (N)	Basic Static Load (N)	Basic Dynamic Load Rating (N)		Basic Static Load Rating (N)		Static Rated Moment											
						Block A	Block S	Block A	Block S	Allowable Static Moment M_P (N·m) (pitching)				Allowable Static Moment M_Y (N·m) (yawing)				Allowable Static Moment M_R (N·m) (rolling)			
Block A	Block S	Block A1	Block A2	Block S1	Block S2	Block A1	Block A2	Block S1	Block S2	Block A1	Block A2	Block S1	Block S2	Block A1	Block A2	Block S1	Block S2				
KKP4001	Precision	8	1	735	1538	3920	-	6468	-	33	182	-	-	33	182	-	-	81	352	-	-
	Normal			676	1284																
KKP5002	Precision	8	2	2136	3489	8007	-	12936	-	116	545	-	-	116	545	-	-	222	444	-	-
	Normal			1813	2910																
KKP6005	Precision	12	5	3744	6243	13230	7173	21462	12574	152	760	72	367	152	760	72	367	419	838	241	482
	Normal			3377	5625																
KKP6080	Precision	12	10	2410	3743	13230	7173	21462	12574	152	760	72	367	152	760	72	367	419	838	241	482
	Normal			2107	3234																
KKP8610	Precision	15	10	7144	12642	31458	21051	50764	29475	622	3050	228	1309	622	3050	228	1309	1507	3014	847	1694
	Normal			6429	11387																
KKP8620	Precision	15	20	4645	7655	31458	21051	50764	29475	622	3050	228	1309	622	3050	228	1309	1507	3014	847	1694
	Normal			4175	6889																
KKP10020	Precision	20	20	7046	12544	39200	-	63406	-	960	4763	-	-	960	4763	-	-	2205	4410	-	-
	Normal			4782	9163																
KKP13025	Precision	20	25	7897	15931	48301	-	84829	-	1536	7350	-	-	1536	7350	-	-	3885	7770	-	-
	Normal			7092	14352																

Linear Module

Accuracy Grade

Model	Rail Length	Repeatability		Accuracy		Running Parallelism		Starting Torque(N-cm)	
		Precision	Normal	Precision	Normal	Precision	Normal	Precision	Normal
KKP40	100	±0.003	±0.01	0.020	-	0.010	-	12	0.8
	150								
	200								
KKP50	150	±0.003	±0.01	0.020	-	0.010	-	4	2
	200								
	250								
	300								
KKP60	150	±0.003	±0.01	0.020	-	0.010	-	15	7
	200								
	300								
	400								
	500	±0.003	±0.01	0.025	-	0.015	-	15	7
	600								
KKP86	340	±0.003	±0.01	0.025	-	0.015	-	15	10
	440								
	540								
	640								
	740	±0.003	±0.01	0.030	-	0.020	-	17	10
	940								
KKP100	980	±0.005	±0.01	0.035	-	0.025	-	17	12
	1080								
	1180	±0.005	±0.01	0.040	-	0.03	-	20	12
	1280								
	1380			0.045		0.04		23	
1380	0.05	0.04	25						
KKP130	980	±0.005	±0.01	0.035	-	0.025	-	25	15
	1180			0.04		0.03		25	15
	1380								
	1680			±0.007		±0.012		0.05	-

Linear Module

Maximum Speed Limit

Model	Ballscrew Lead (mm)	Rail Length (mm)	Speed (mm/sec)	
			Precision	Normal
KKP40	01	100	190	190
		150	190	190
		200	190	190
KKP50	02	150	270	270
		200	270	270
		250	270	270
		300	270	270
KKP60	05	150	550	390
		200	550	390
		300	550	390
		400	550	390
		500	550	390
		600	340	340
	10	150	1100	790
		200	1100	790
		300	1100	790
		400	1100	790
		500	1100	790
		600	670	670
KKP80	10	340	740	520
		440	740	520
		540	740	520
		640	740	520
		740	740	520
		940	610	430
	20	340	1480	1050
		440	1480	1050
		540	1480	1050
		640	1480	1050
		740	1480	1050
		940	1220	870
KKP100	20	980	1120	800
		1080	980	800
		1180	750	750
		1280	510	630
		1380	440	530
KKP130	25	980	1120	800
		1180	1120	800
		1380	830	800
		1680	550	550

Linear Module

Life Calculations

Service Life

Under repeated stress between the raceway and the rolling elements, pitting and flaking will occur as it reaches fatigue failure. The service life of the KKP Single Axis Robot is defined as the distanced traveled before any failure of the raceway or rolling elements appear.

Nominal Life (L)

The service life varies greatly even when the KKP units are manufactured in the same way or operated under the same conditions. For this reason, nominal life is used as the criteria for predicting the service life of a KKP unit.

Nominal Life Calculation

The calculating formulas are divided into two parts, guideway and ballscrew. The smaller value of the two would be the recommended nominal Life of the KKP unit.

Nominal life formulas for both the guideway and ballscrew depend on several parameters and are shown below.

Guideway

$$L = \left(\frac{f_t}{f_w} \cdot \frac{C}{P_n} \right)^3 \times 50 \text{ km}$$

L : Life Rating (km)

f_t : Contact Coefficient (ref. Table 1)

f_w : Loading Coefficient (ref. Table 2)

C : Basic Dynamic Load Rating (N)

P_n : Calculated Loading (N)

Table 1

Block Type	Contact Coefficient f_t
A1,S1	1.0
A2,S2	0.81

Table 2

Operating Condition		Loading Coefficient f_w
Operating Condition	Velocity (V)	
No Thrust	$V < 15\text{m/min}$	1.0 ~ 1.5
Low Vibration	$15\text{m/min} < V < 60\text{m/min}$	1.5 ~ 2.0
High Vibration	$V > 60\text{m/min}$	2.0 ~ 3.5

Ballscrew and Bearing

$$L = \left(\frac{1}{f_w} \cdot \frac{C_a}{P_{a,n}} \right)^3 \times 10^6 \text{ rev}$$

L : Life Rating (rev)

f_w : Loading Coefficient (ref. Table 2)

C_a : Basic Dynamic Load Rating (N)

$P_{a,n}$: Axial Loading (N)

Linear Module

Lubrication

Insufficient lubrication of the guideway would lead to a reduction of the service life. The lubricant provides the following functions:

- Reducing rolling friction and avoiding abrasion
- Providing a lubricating film and extending the service life
- Anti-rusting

Lubricating Grease

Re-lubricating the KKP Single Axis Robot every 100km is recommended. Generally, grease is applied for speeds under 60 m/min. For operating speeds over 60 m/min, a grease with a higher viscosity should be used.

$$T = \frac{100 \times 1000}{V_e \times 60}$$

T: Lubricating frequency (hrs)
V_e: Speed (m/min)

Grease Nipple

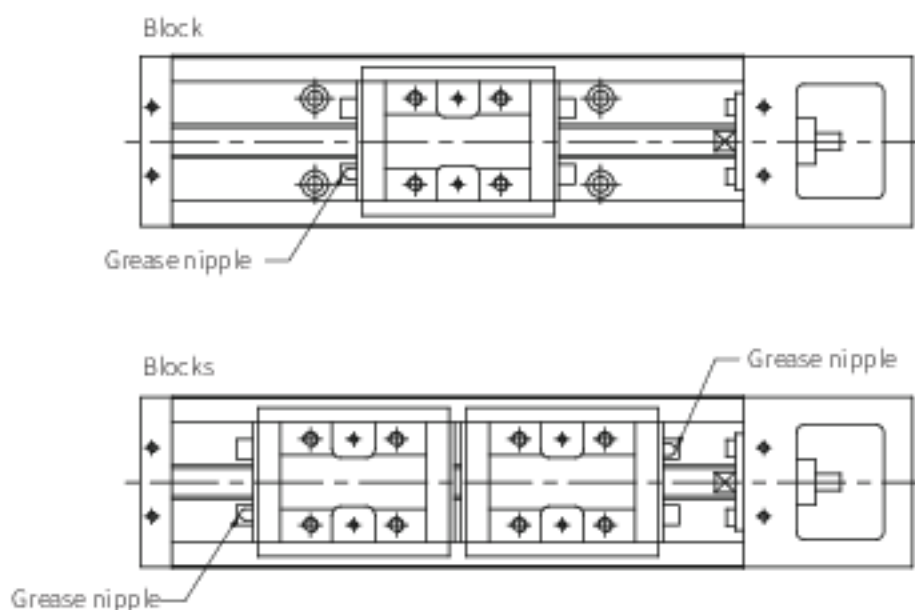

Linear Module

Dimensions

Without cover

KKP40

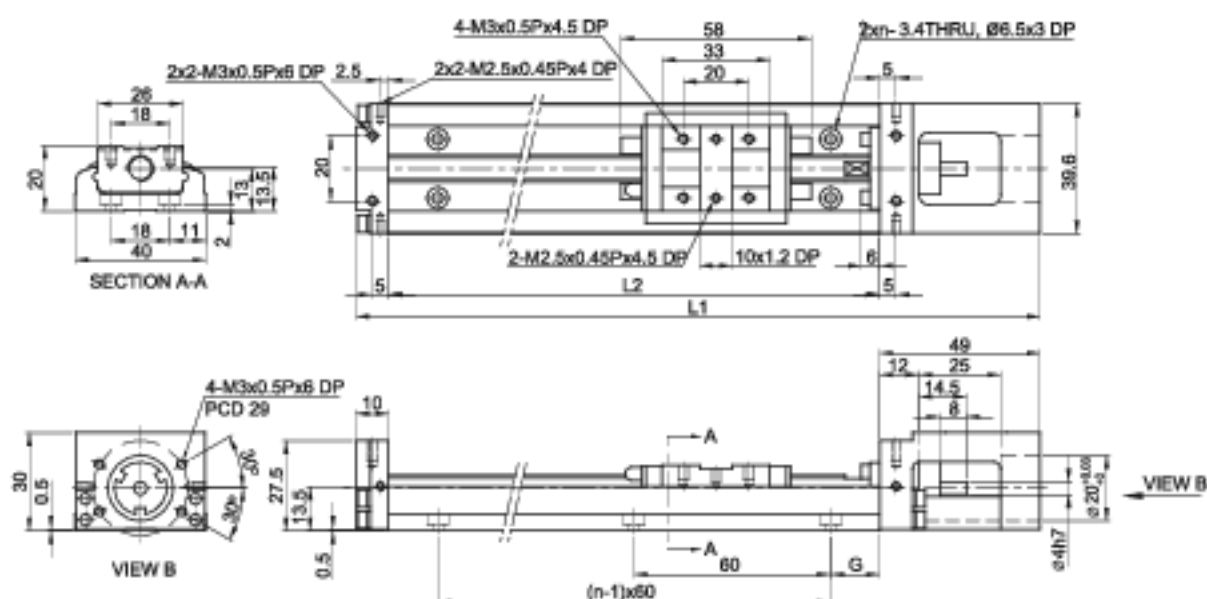

Rail Length L2 (mm)	Total Length L1 (mm)	Maximum Stroke (mm)		G (mm)	n	Mass (kg)	
		A1 Block	A2 Block			A1 Block	A2 Block
100	159	36	-	20	2	0.48	-
150	209	86	34	15	3	0.6	0.67
200	259	136	84	40	3	0.72	0.79

KKP50

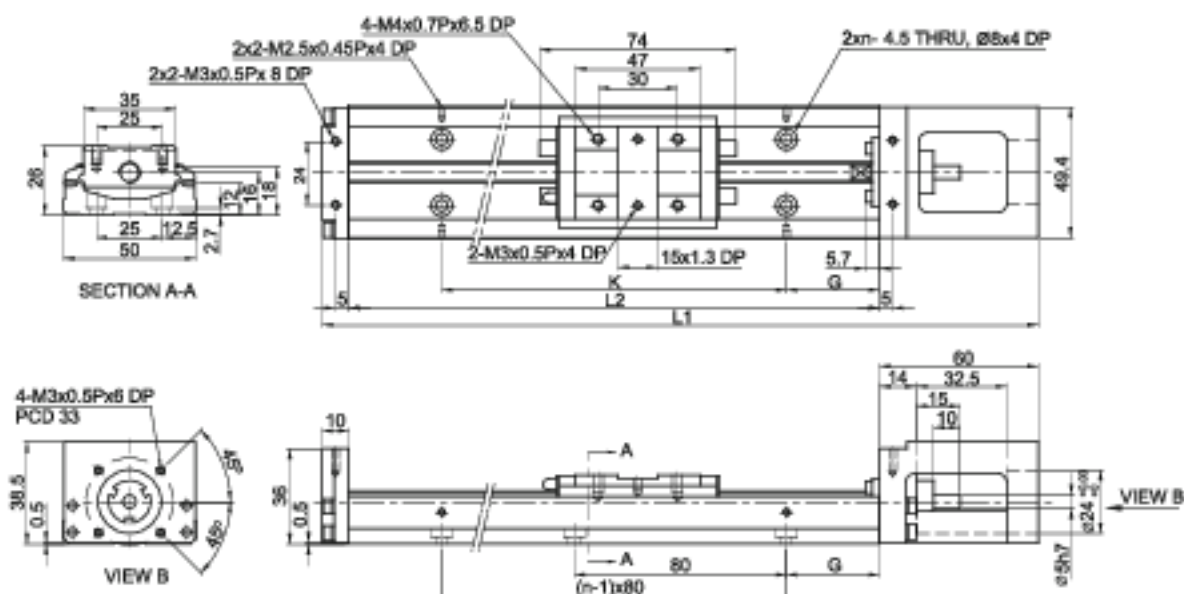

Rail Length L2 (mm)	Total Length L1 (mm)	Maximum Stroke (mm)		G (mm)	K (mm)	n	Mass (kg)	
		A1 Block	A2 Block				A1 Block	A2 Block
150	220	70	-	35	80	2	1	-
200	270	120	55	20	160	3	1.2	1.4
250	320	170	105	45	160	3	1.4	1.6
300	370	220	155	30	240	4	1.6	1.8

Linear Module

Dimensions

KKP60(Standard)

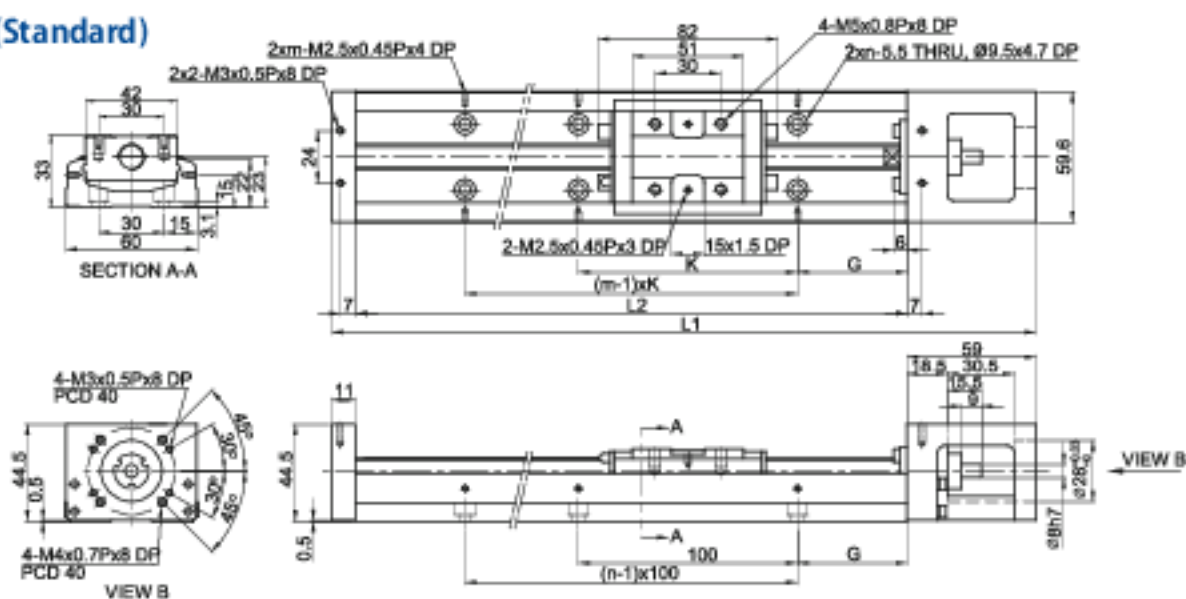

Rail Length L2 (mm)	Total Length L1 (mm)	Maximum Stroke (mm)		G (mm)	K (mm)	n	m	Mass (kg)	
		A1 Block	A2 Block					A1 Block	A2 Block
150	220	60	-	25	100	2	2	1.5	-
200	270	110	-	50	100	2	2	1.8	-
300	370	210	135	50	200	3	2	2.4	2.7
400	470	310	235	50	100	4	4	3	3.3
500	570	410	335	50	200	5	3	3.6	3.9
600	670	510	435	50	100	6	6	4.2	4.6

KKP60(Light Duty)

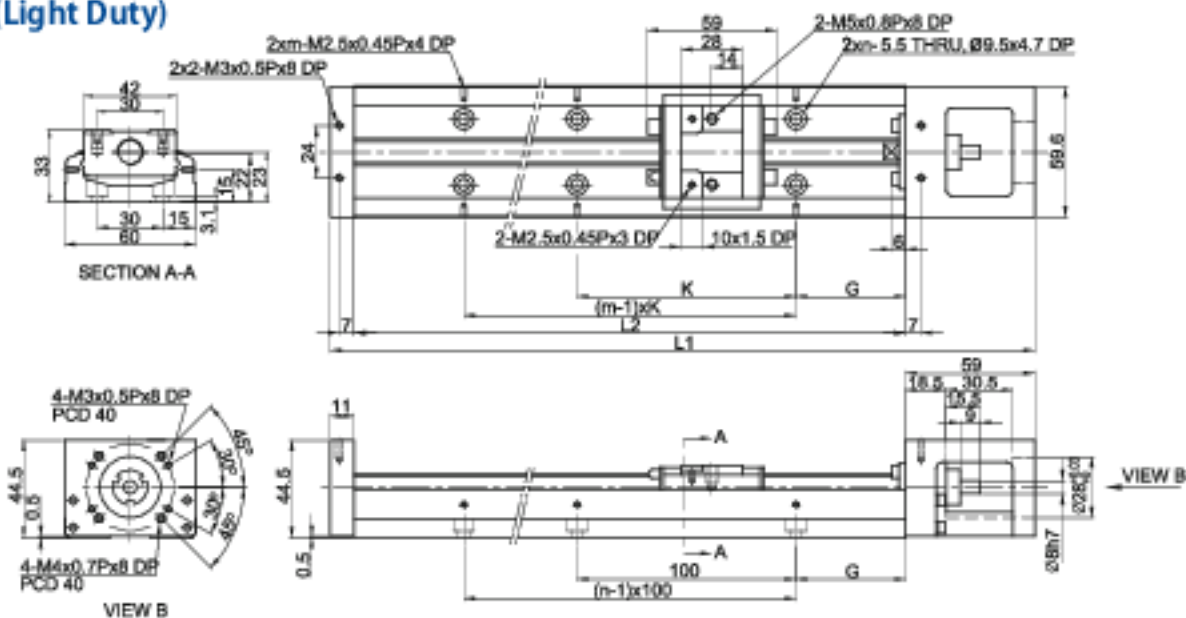

Rail Length L2 (mm)	Total Length L1 (mm)	Maximum Stroke (mm)		G (mm)	K (mm)	n	m	Mass (kg)	
		A1 Block	A2 Block					A1 Block	A2 Block
150	220	85	34	25	100	2	2	1.4	1.6
200	270	135	84	50	100	2	2	1.7	1.9
300	370	235	184	50	200	3	2	2.3	2.5
400	470	335	284	50	100	4	4	2.9	3.1
500	570	435	384	50	200	5	3	3.5	3.7
600	670	535	484	50	100	6	6	4.1	4.3

Linear Module

Dimensions

KKP86 (Standard)

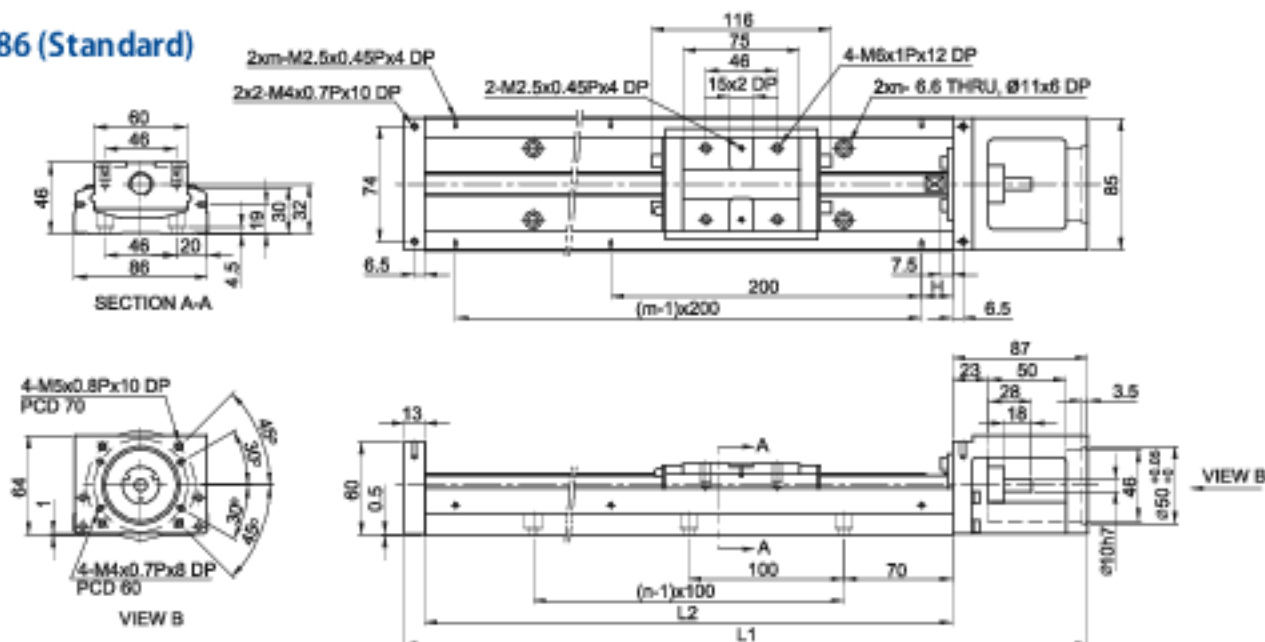

Rail Length L2 (mm)	Total Length L1 (mm)	Maximum Stroke (mm)		H (mm)	n	m	Mass (kg)	
		A1 Block	A2 Block				A1 Block	A2 Block
340	440	210	100	70	3	2	5.7	6.5
440	540	310	200	20	5	3	6.9	7.7
540	640	410	300	70	5	3	8.0	8.8
640	740	510	400	20	7	4	9.2	10.0
740	840	610	500	70	7	4	10.4	11.2
940	1040	810	700	70	9	5	11.6	12.4

KKP86 (Light Duty)

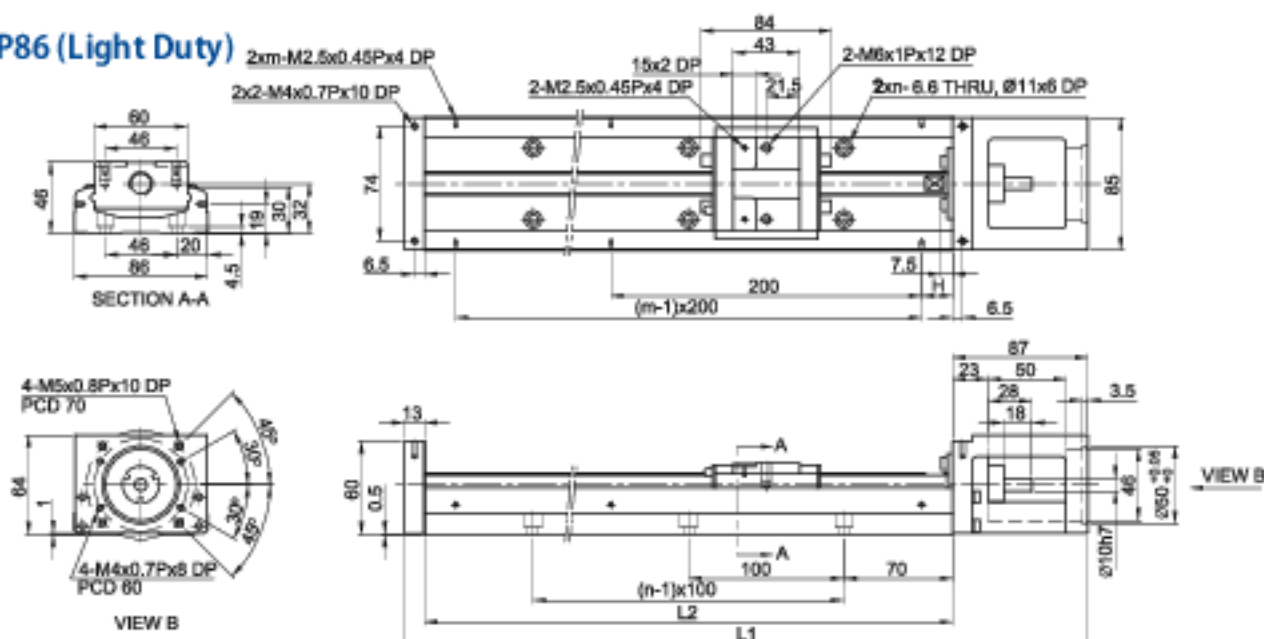

Rail Length L2 (mm)	Total Length L1 (mm)	Maximum Stroke (mm)		H (mm)	n	m	Mass (kg)	
		A1 Block	A2 Block				A1 Block	A2 Block
340	440	246	170	70	3	2	5.4	5.9
440	540	346	270	20	5	3	6.6	7.1
540	640	446	370	70	5	3	7.7	8.2
640	740	546	470	20	7	4	8.9	9.4
740	840	646	570	70	7	4	10.1	10.6
940	1040	846	770	70	9	5	11.3	11.8

Linear Module

Dimensions

KKP100

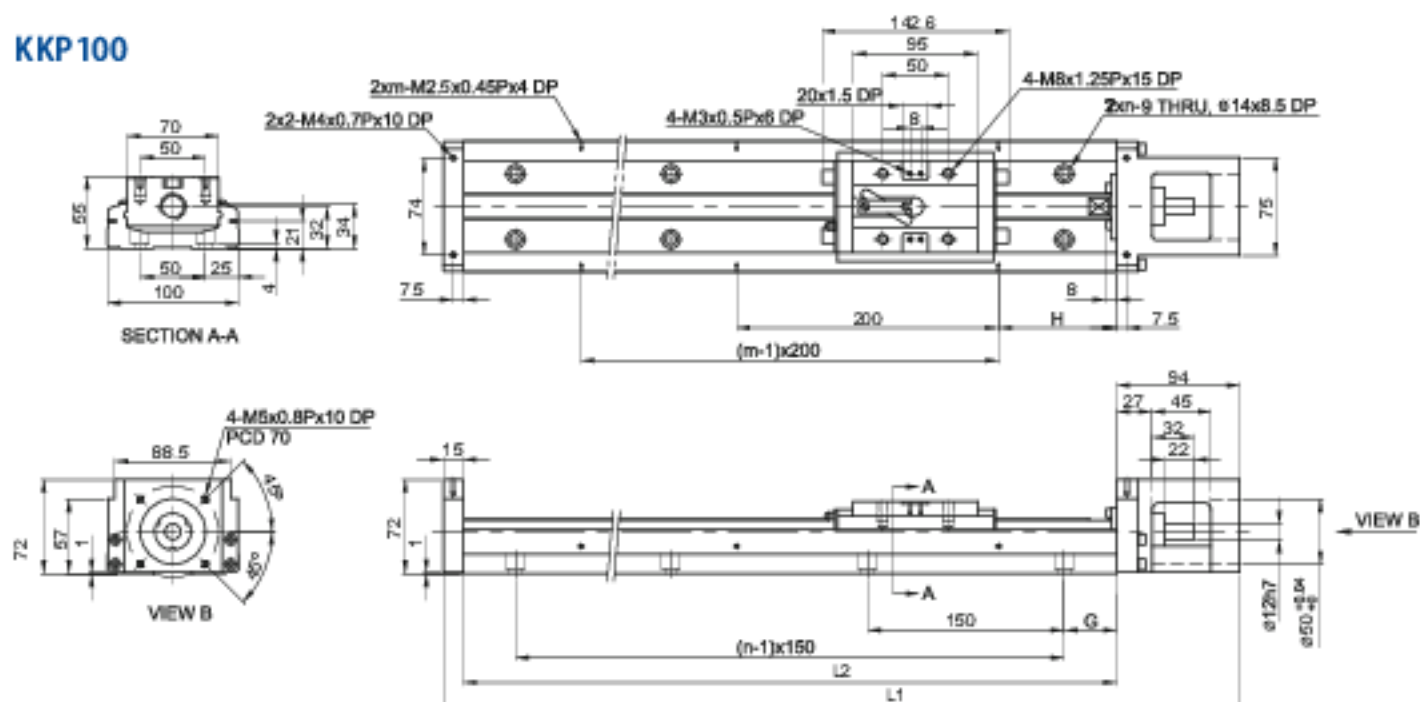

Rail Length L2 (mm)	Total Length L1 (mm)	Maximum Stroke (mm)		G (mm)	K (mm)	n	m	Mass (kg)	
		A1 Block	A2 Block					A1 Block	A2 Block
980	1089	828	700	40	90	7	5	18.6	20.3
1080	1189	928	800	15	40	8	6	20.3	22.0
1180	1289	1028	900	65	90	8	6	22.0	23.7
1280	1389	1128	1000	40	40	9	7	23.6	25.3
1380	1489	1228	1100	15	90	10	7	25.3	27.0

KKP130

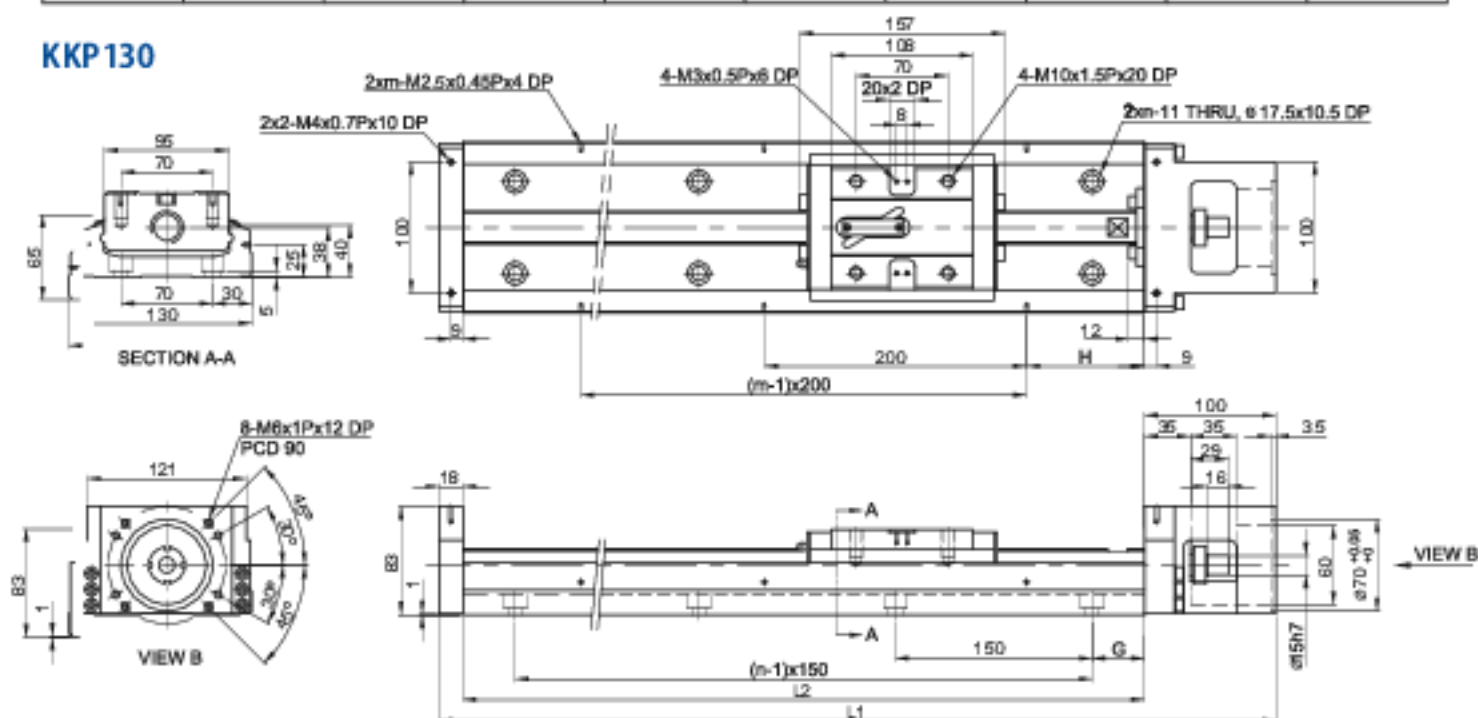

Rail Length L2 (mm)	Total Length L1 (mm)	Maximum Stroke (mm)		G (mm)	K (mm)	n	m	Mass (kg)	
		A1 Block	A2 Block					A1 Block	A2 Block
980	1098	811	659	40	90	7	5	29.4	32.3
1180	1298	1011	859	65	90	8	6	34.3	37.2
1380	1498	1211	1059	90	90	9	7	39.2	42.1
1680	1798	1511	1359	90	40	11	9	46.5	49.4

Linear Module

Dimensions

Without cover

KKP40

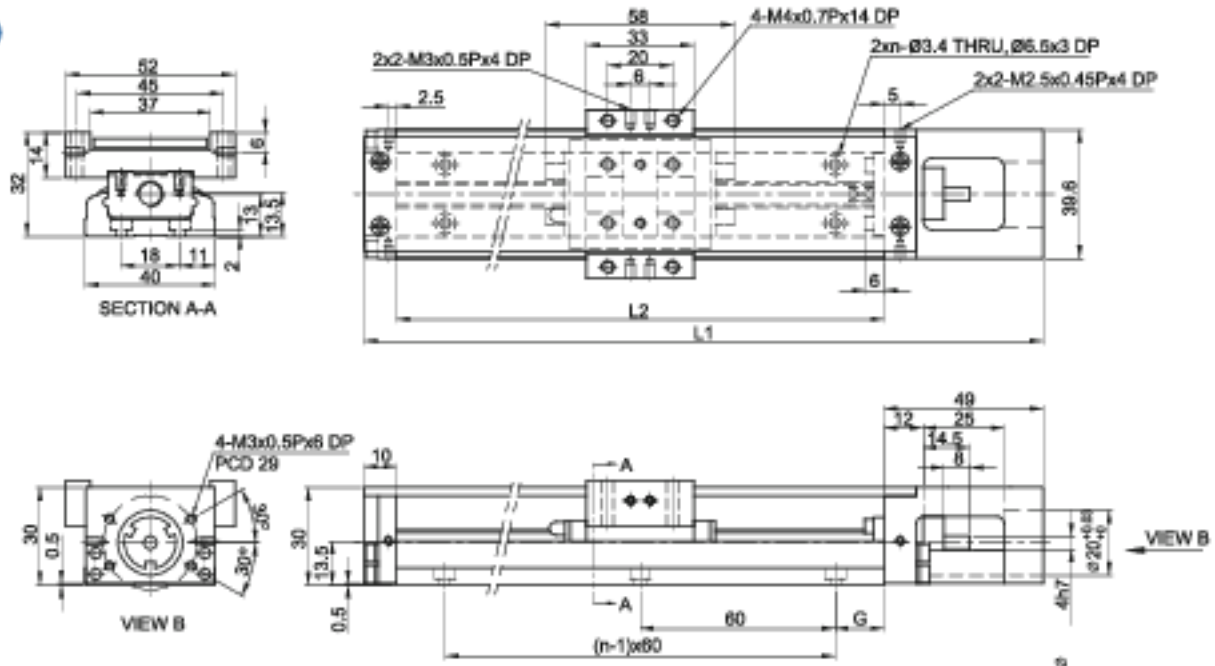

Rail Length L2 (mm)	Total Length L1 (mm)	Maximum Stroke (mm)		G (mm)	n	Mass (kg)	
		A1 Block	A2 Block			A1 Block	A2 Block
100	159	36	-	20	2	0.55	-
150	209	86	34	15	3	0.68	0.76
200	259	136	84	40	3	0.82	0.89

KKP50

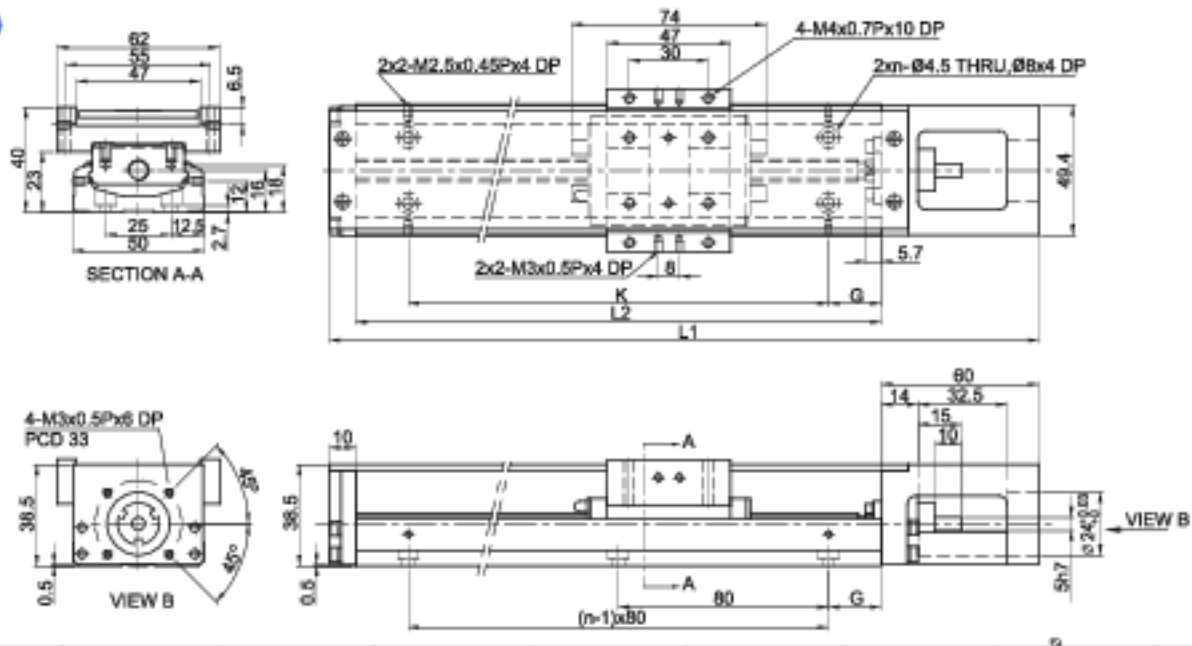

Rail Length L2 (mm)	Total Length L1 (mm)	Maximum Stroke (mm)		G (mm)	K (mm)	n	Mass (kg)	
		A1 Block	A2 Block				A1 Block	A2 Block
150	220	70	-	35	80	2	1.1	-
200	270	120	55	20	160	3	1.3	1.5
250	320	170	105	45	160	3	1.6	1.8
300	370	220	155	30	240	4	1.8	2.0

Linear Module

Dimensions

KKP60(Standard)

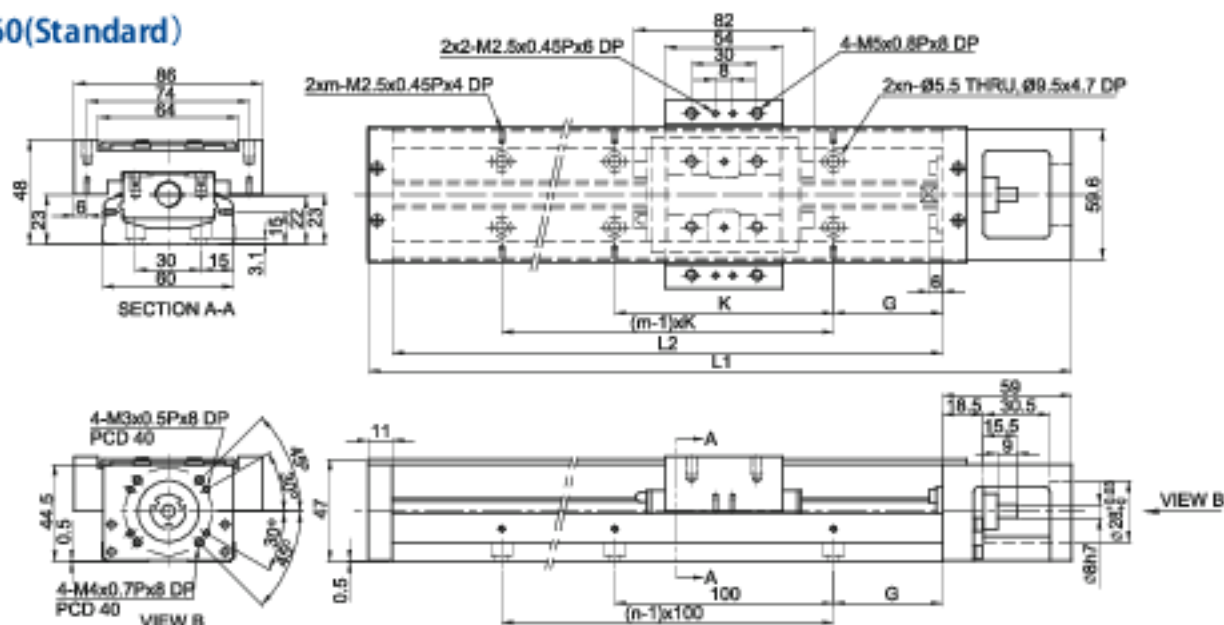

Rail Length L2 (mm)	Total Length L1 (mm)	Maximum Stroke (mm)		G (mm)	K (mm)	n	m	Mass (kg)	
		A1 Block	A2 Block					A1 Block	A2 Block
150	220	60	-	25	100	2	2	1.7	-
200	270	110	-	50	100	2	2	2.1	-
300	370	210	135	50	200	3	2	2.7	3.0
400	470	310	235	50	100	4	4	3.3	3.6
500	570	410	335	50	200	5	3	3.9	4.2
600	670	510	435	50	100	6	6	4.6	5.0

KKP60 (Light Duty)

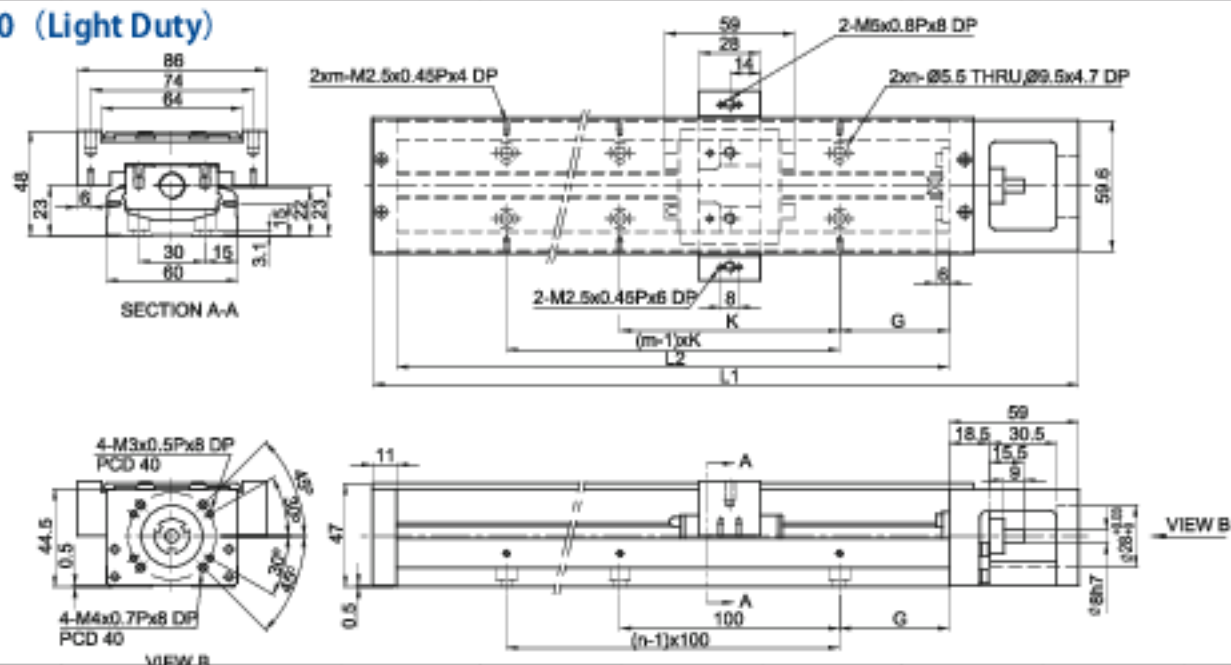

Rail Length L2 (mm)	Total Length L1 (mm)	Maximum Stroke (mm)		G (mm)	K (mm)	n	m	Mass (kg)	
		A1 Block	A2 Block					A1 Block	A2 Block
150	220	85	34	25	100	2	2	1.6	1.8
200	270	135	84	50	100	2	2	1.9	2.1
300	370	235	184	50	200	3	2	2.5	2.7
400	470	335	284	50	100	4	4	3.1	3.3
500	570	435	384	50	200	5	3	3.7	3.9
600	670	535	484	50	100	6	6	4.4	4.6

Linear Module

Dimensions

KKP86 (Standard)

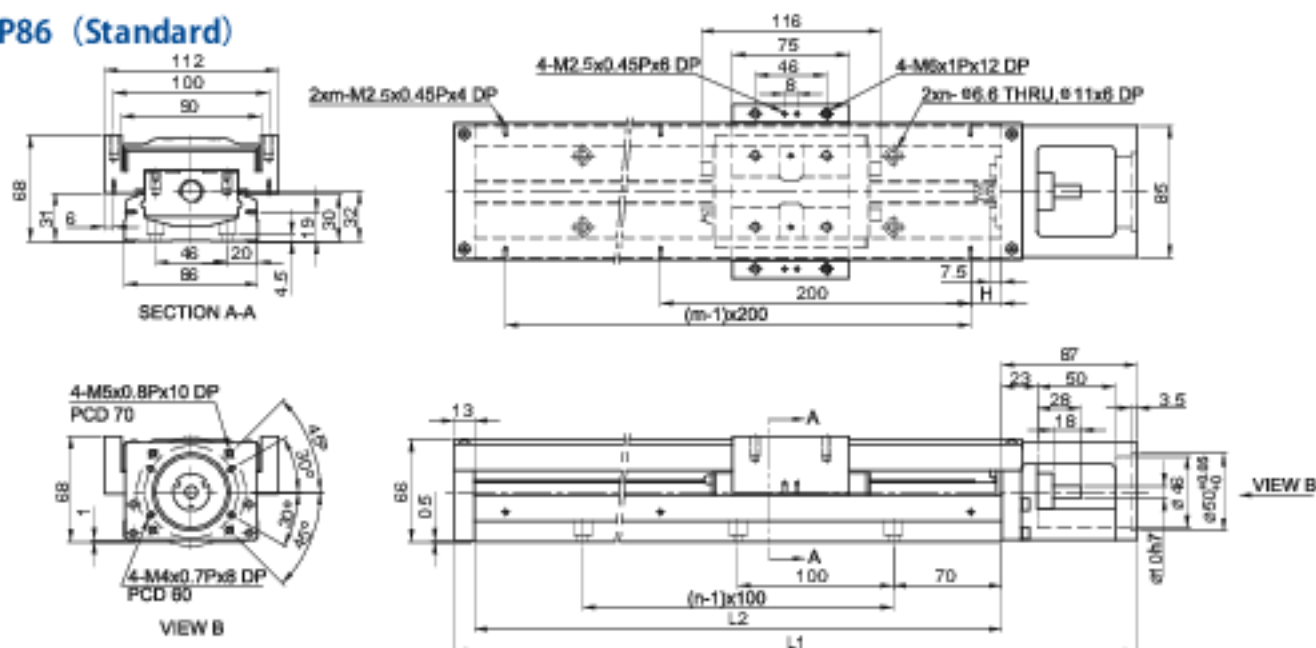

Rail Length L2 (mm)	Total Length L1 (mm)	Maximum Stroke (mm)		H (mm)	n	m	Mass (kg)	
		A1 Block	A2 Block				A1 Block	A2 Block
340	440	210	100	70	3	2	6.5	7.3
440	540	310	200	20	4	3	7.8	8.6
540	640	410	300	70	5	3	9.0	9.8
640	740	510	400	20	6	4	10.3	11.3
740	840	610	500	70	7	4	11.6	12.4
940	1040	810	700	70	9	5	13.0	13.8

KKP86 (Light Duty)

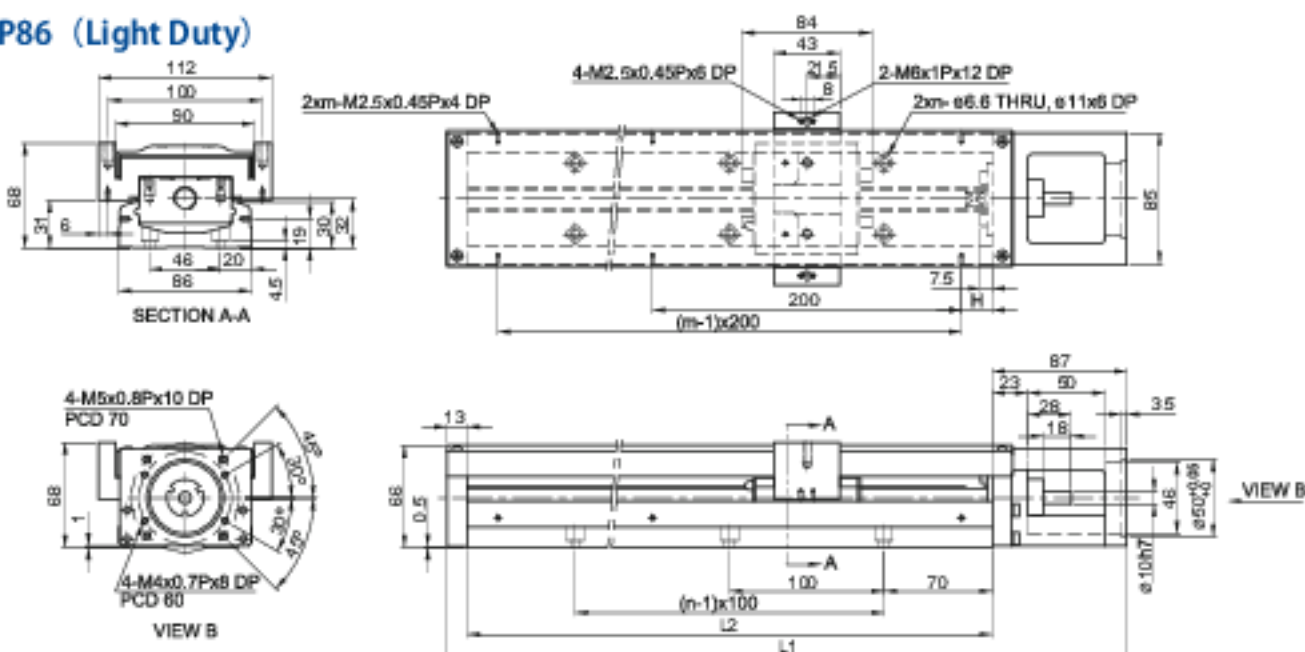

Rail Length L2 (mm)	Total Length L1 (mm)	Maximum Stroke (mm)		H (mm)	n	m	Mass (kg)	
		A1 Block	A2 Block				A1 Block	A2 Block
340	440	246	170	70	3	2	6.3	7.1
440	540	346	270	20	4	3	7.6	8.4
540	640	446	370	70	5	3	8.8	9.6
640	740	546	470	20	6	4	10.1	11.1
740	840	646	570	70	7	4	11.4	12.2
1040	846	770	70	9	5	12.8	13.6	13.8

Linear Module

Dimensions

KKP100

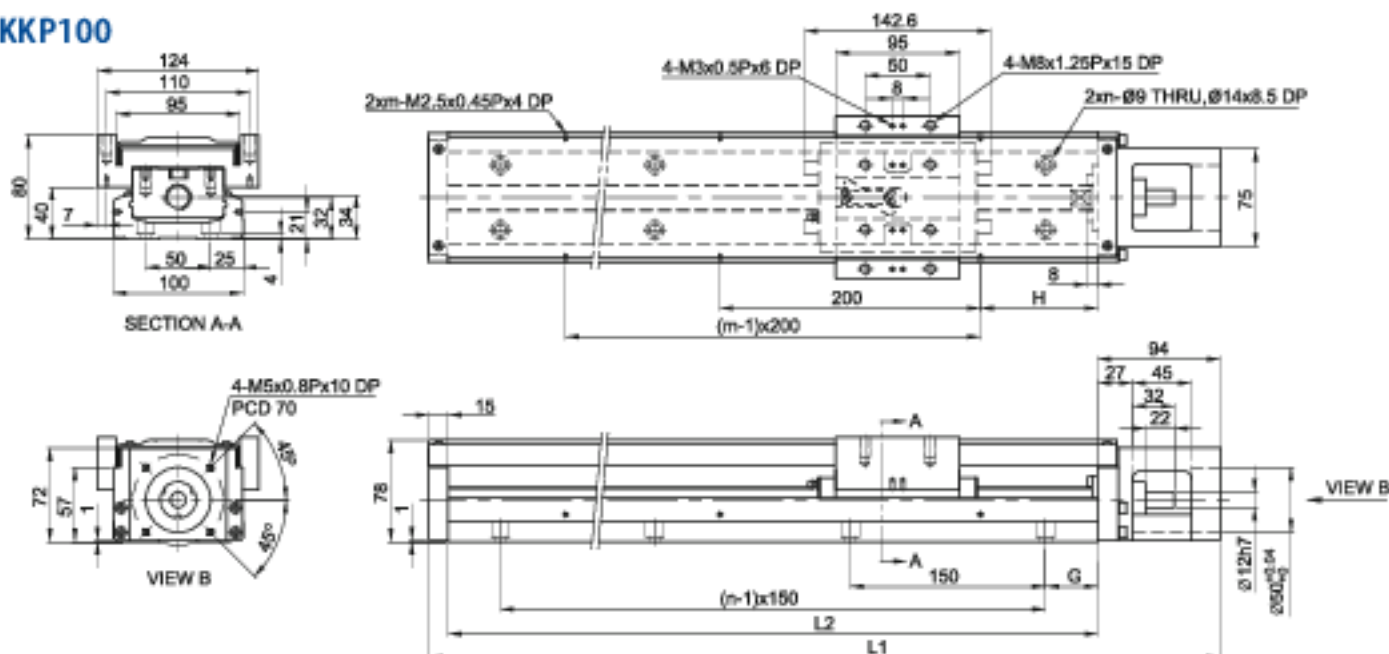

Rail Length L2 (mm)	Total Length L1 (mm)	Maximum Stroke (mm)		G(mm)	H(mm)	n	m	Mass (kg)	
		A1 Block	A2 Block					A1 Block	A2 Block
980	1089	828	700	40	90	7	5	20.4	22.1
1080	1189	928	800	15	40	8	6	22.2	23.9
1180	1289	1028	900	65	90	8	6	24.0	25.7
1280	1389	1128	1000	40	40	9	7	25.7	27.4
1380	1489	1228	1100	15	90	10	7	27.5	29.2

KKP130

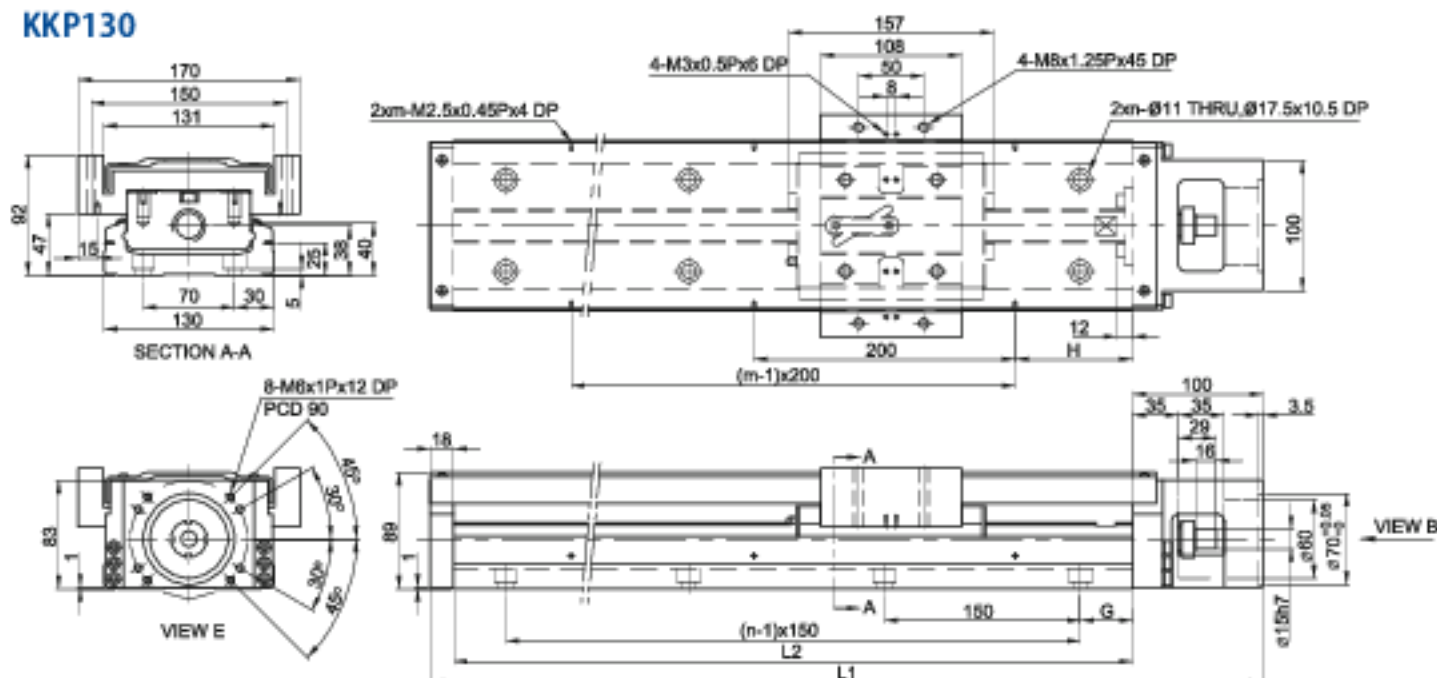

Rail Length L2 (mm)	Total Length L1 (mm)	Maximum Stroke (mm)		G(mm)	H(mm)	n	m	Mass (kg)	
		A1 Block	A2 Block					A1 Block	A2 Block
980	1089	828	700	40	90	7	5	20.4	22.1
1080	1189	928	800	15	40	8	6	22.2	23.9
1180	1289	1028	900	65	90	8	6	24.0	25.7
1280	1389	1128	1000	40	40	9	7	25.7	27.4

Linear Module

Motor Housing and Motor Adaptor Flange

Motor Selection

ALM Mikrosystem Servo Motor

Motor Output	Motor	Weight (kg)	Flange Selection						Brake Weight (Kg)	Driver	Weight (kg)	Remarks
			KKP40	KKP50	KKP60	KKP86	KKP100	KKP130				
100W	FRAC101022	0.6	F2	F2	F2	F3	-	-	-	MD-36-S	1.25	220V
200W	FRAC102022	1	-	-	-	F0	F0	F1	-			220V
400W	FRAC104022	1.45	-	-	-	F0	F0	F1	-			220V
750W	FRAC107522	2.66	-	-	-	-	F1	F2	-			220V

Mitsubishi Servo Motor

Motor Output	Motor	Weight (kg)	Flange Selection						Brake Weight (Kg)	Driver	Weight (kg)	Remarks
			KKP40	KKP50	KKP60	KKP86	KKP100	KKP130				
50W	HF-KP053	0.35	F1	F1	F1	F2	-	-	0.75	MR-J3S-10A	0.8	220V
100W	HF-KP13	0.56	F1	F1	F1	F2	-	-	0.89	MR-J3S-10A	0.8	220V
200W	HF-KP23	0.94	-	-	-	F0	F0	F1	1.6	MR-J3S-20A	0.8	220V
400W	HF-KP43	1.5	-	-	-	F0	F0	F1	2.1	MR-J3S-40A	1	220V
750W	HF-KP73	2.9	-	-	-	-	F1	F2	4	MR-J3S-70A	1.4	220V

Panasonic Servo Motor

Motor Output	Motor	Weight (kg)	Flange Selection						Brake Weight (Kg)	Driver	Weight (kg)	Remarks
			KKP40	KKP50	KKP60	KKP86	KKP100	KKP130				
50W	MSMD5AZP1	0.32	F2	F2	F2	F3	-	-	0.53	MADDT1105	0.8	110V
50W	MSMD5AZP1	0.32	F2	F2	F2	F3	-	-	0.53	MADDT1205	0.8	220V
100W	MSMD011P1	0.47	F2	F2	F2	F3	-	-	0.68	MADDT1107	0.8	110V
100W	MSMD012P1	0.47	F2	F2	F2	F3	-	-	0.68	MADDT1205	0.8	220V
200W	MSMD021P1	0.82	-	-	-	F1	-	-	1.3	MADDT2110	1.1	110V
200W	MSMD022P1	0.82	-	-	-	F1	-	-	1.3	MADDT1207	0.8	220V
400W	MSMD041P1	1.2	-	-	-	F1	-	-	1.7	MADDT3120	1.5	110V
400W	MSMD042P1	1.2	-	-	-	F1	-	-	1.7	MADDT2210	1.1	220V
750W	MSMD082S1	2.3	-	-	-	F4	F2	F4	3.1	MADDT3520	1.5	220V

Yasukawa Servo Motor

Motor Output	Motor	Weight (kg)	Flange Selection						Brake Weight (Kg)	Driver	Weight (kg)	Remarks
			KKP40	KKP50	KKP60	KKP86	KKP100	KKP130				
50W	SGMAV-A5ADA61	0.3	F1	F1	F1	F2	-	-		SGDV-R70A01A	0.9	with key
50W	SGMAV-A5ADA2C	0.3	F1	F1	F1	F2	-	-		SGDV-R70A01A	0.9	no key
50W	SGMAV-A5ADA21	0.3	F1	F1	F1	F2	-	-	0.75	SGDV-R70A01A	0.9	Mid inertia
100W	SGMAV-01ADA64	0.4	F1	F1	F1	F2	-	-	0.89	SGDV-R90A01A	0.9	
200W	SGMAV-02ADA65	0.9	-	-	-	F0	F0	F1	1.6	SGDV-1R6A01A	0.9	
400W	SGMAV-04ADA66	1.2	-	-	-	F0	F0	F1	2.1	SGDV-2R8A01A	1	
750W	SGMAV-08ADA67	2.6	-	-	-	-	F1	F2	4	SGDV-5R5A01A	1.5	

Linear Module

Motor Housing and Motor Adaptor Flange

ALM Mikosystem Step Motor

Series	Model	Flange Selection						Weight (kg)	Built in Motor	Weight (kg)	Remarks
		KKP10	KKP50	KKP60	KKP86	KKP100	KKP130				
ST40	FRST01 1024	F3	F3	F5	-	-	-	0.3	STD-24A	0.09	single axis
ST55	FRST02 1024	F3	F3	F5	-	-	-	0.55			single axis
	FRST02 2024				-	-	-	0.8			
	FRST02 3024				-	-	-	1.18			
	FRST12 1024	F3	F3	F5	-	-	-	0.58			
	FRST12 2024				-	-	-	0.83			
FRST12 3024	-				-	-	0.21				
										axis of symmetry	

Oriental Step Motor

Series	Model	Flange Selection						Built in Motor	Weight (kg)	Built in Motor	Weight (kg)
		KKP10	KKP50	KKP60	KKP86	KKP100	KKP130				
CSK 2 phase	CSK243-AP	F3	F3	F5	-	-	-	PK243-01A	0.21	CSD2109-P	0.12
	CSK244-AP	F3	F3	F5	-	-	-	PK244-01A	0.27	CSD2112-P	0.12
	CSK245-AP	F3	F3	F5	-	-	-	PK245-01A	0.35	CSD2112-P	0.12
	CSK264-AP	-	-	F4	F6	-	-	PK264-02A	0.45	CSD2120-P	0.12
	CSK266-AP	-	-	F4	F6	-	-	PK266-02A	0.7	CSD2120-P	0.12
	CSK268-AP	-	-	F4	F6	-	-	PK268-02A	1	CSD2120-P	0.12
	CSK296-AP	-	-	-	-	F4	F3	PK296-03A	1.7	CSD2145P	0.2
	CSK299-AP	-	-	-	-	F4	F3	PK299-03A	2.8	CSD2145P	0.2
CFK 5 phase micro stepping	CFK543AP2	F3	F3	F5	-	-	-	PK543NAW	0.21	DFC5107P	0.2
	CFK544AP2	F3	F3	F5	-	-	-	PK544NAW	0.27	DFC5107P	0.2
	CFK545AP2	F3	F3	F5	-	-	-	PK545NAW	0.35	DFC5107P	0.2
	CFK564AP2	-	-	-	F5	-	-	PK564NAW	0.6	DFC5114P	0.2
	CFK566AP2	-	-	-	F5	-	-	PK566NAW	0.8	DFC5114P	0.2
	CFK569AP2	-	-	-	F5	-	-	PK569NAW	1.3	DFC5114P	0.2
	CFK566HAP2	-	-	-	F5	-	-	PK566HNAW	0.8	DFC5128P	0.22
	CFK569HAP2	-	-	-	F5	-	-	PK569HNAW	1.3	DFC5128P	0.22
	CFK596HAP2	-	-	-	-	F3	-	PK596HNAW	1.7	DFC5128P	0.22
	CFK599HAP2	-	-	-	-	F3	-	PK599HNAW	2.8	DFC5128P	0.22
	CFK5913HAP2	-	-	-	-	F3	-	PK5913HNAW	3.8	DFC5128P	0.22
UMK 2 phase	UMK243A	F3	F3	F5	-	-	-	PK243-01	0.21	UDK2109	0.47
	UMK244A	F3	F3	F5	-	-	-	PK244-01	0.27	UDK2112	0.47
	UMK245A	F3	F3	F5	-	-	-	PK245-01	0.35	UDK2112	0.47
	UMK264A	-	-	F4	F6	-	-	PK264-02	0.45	UDK2120	0.47
	UMK266A	-	-	F4	F6	-	-	PK266-02	0.7	UDK2120	0.47
	UMK268A	-	-	F4	F6	-	-	PK268-02	1	UDK2120	0.47
RK 5 phase	RK543AA	F3	F3	F5	-	-	-	PK543W	0.25	RKD507-A	0.4
	RK544AA	F3	F3	F5	-	-	-	PK544W	0.3	RKD507-A	0.4
	RK545AA	F3	F3	F5	-	-	-	PK545W	0.4	RKD507-A	0.4
	RK566AA	-	-	-	F5	-	-	PK566W	0.8	RKD514L-A	0.85
	RK569AA	-	-	-	F5	-	-	PK569W	1.3	RKD514L-A	0.85
	RK596AA	-	-	-	-	F3	-	PK596W	1.7	RKD514H-A	0.85
	RK599AA	-	-	-	-	F3	-	PK599W	2.8	RKD514H-A	0.85
RK5913AA	-	-	-	-	F3	-	PK5913W	3.8	RKD514H-A	0.85	

Linear Module

Motor Housing and Motor Adaptor Flange

KKP40

Motor Housing F0



Motor Adaptor Flange F1

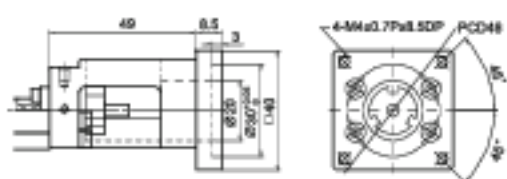

Motor Adaptor Flange F3

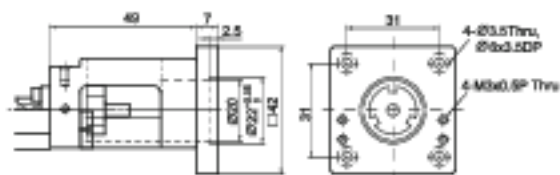

Motor Adaptor Flange F2

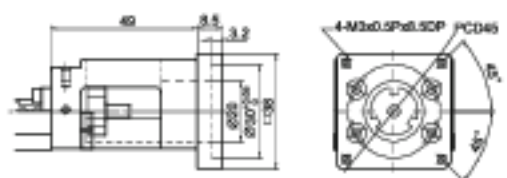

Motor Housing H0

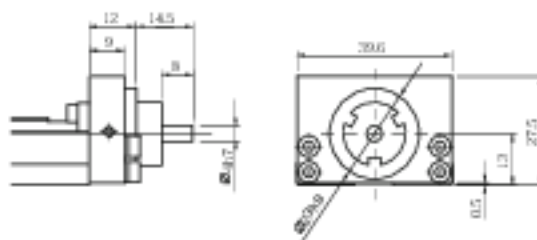

KKP50

Motor Housing F0

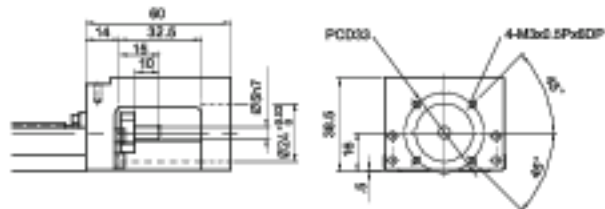

Motor Adaptor Flange F1

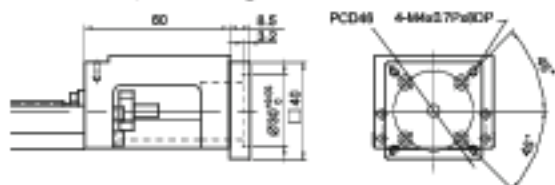

Motor Adaptor Flange F3

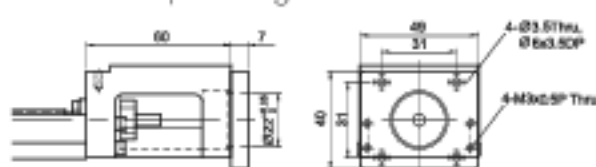

Motor Adaptor Flange F2

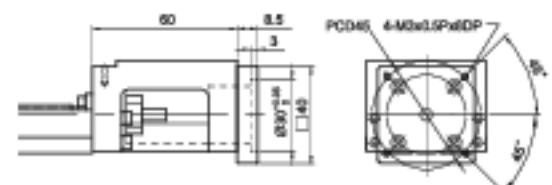

Motor Housing H0

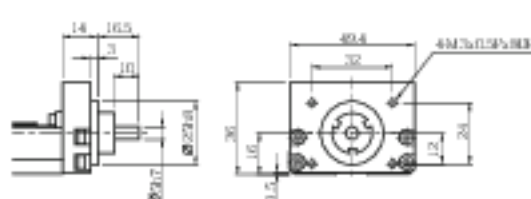

Linear Module

Motor Housing and Motor Adaptor Flange

KKP60

Motor Housing F0

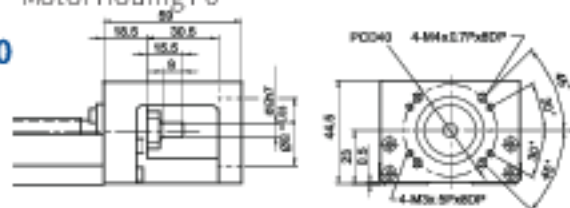

Motor Adaptor Flange F3

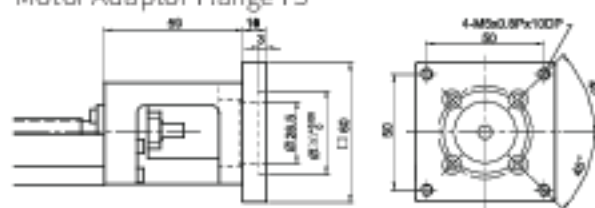

Motor Adaptor Flange F1

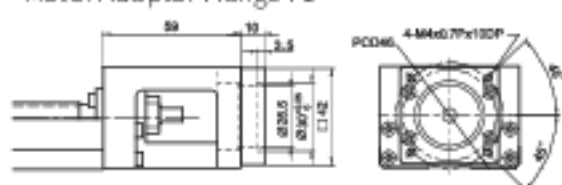

Motor Adaptor Flange F4

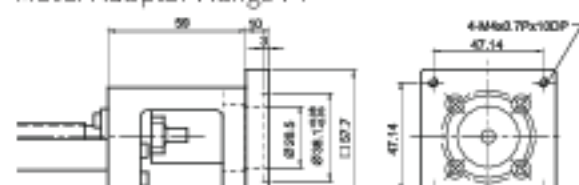

Motor Adaptor Flange F2

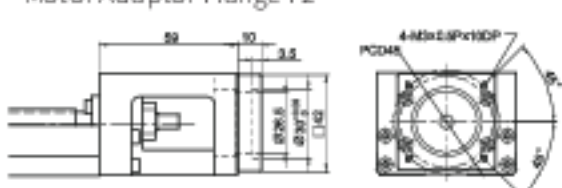

Motor Adaptor Flange F5

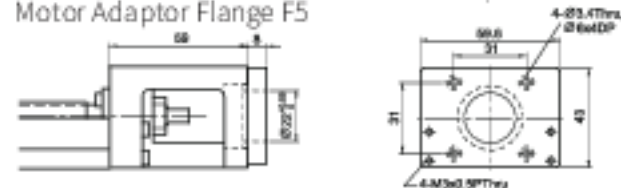

Motor Housing H0

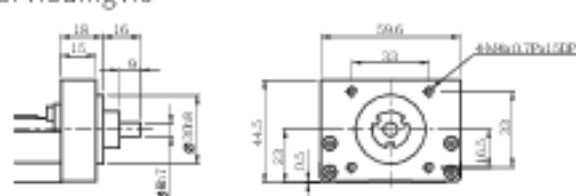

Motor Housing H1

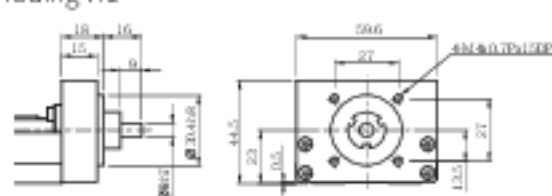

KKP86

Motor Housing F0

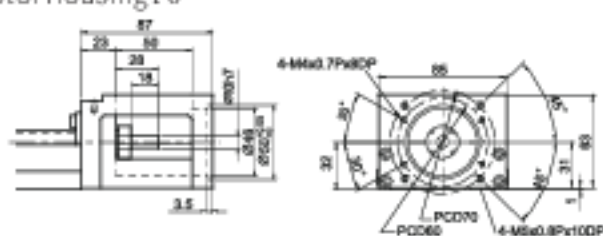

Motor Adaptor Flange F4

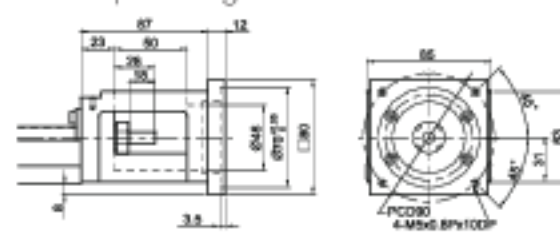

Motor Adaptor Flange F1

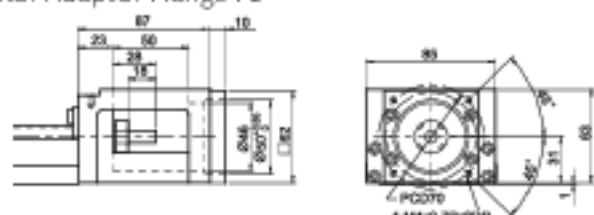

Motor Adaptor Flange F5

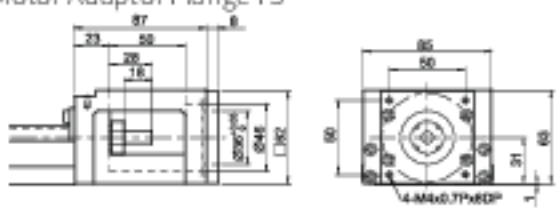

Motor Adaptor Flange F2

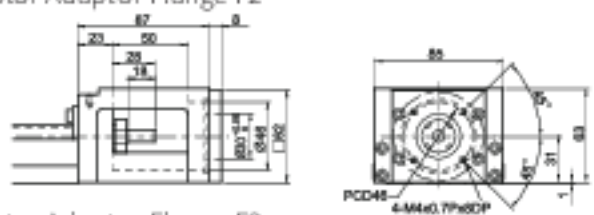

Motor Adaptor Flange F6

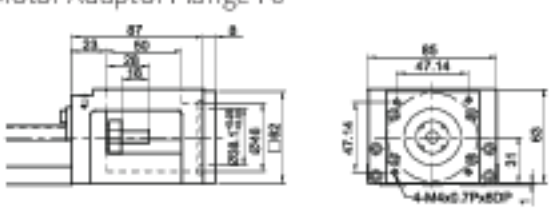

Motor Adaptor Flange F3

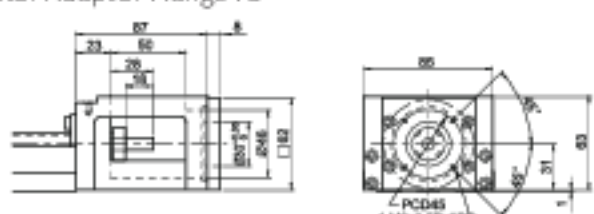

Motor Housing H0

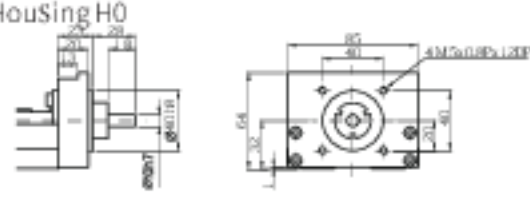

Linear Module

Motor Housing and Motor Adaptor Flange

KKP100

Motor Housing F0

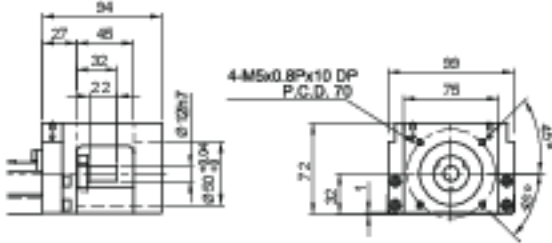

Motor Adaptor Flange F3

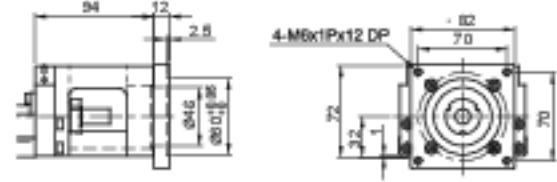

Motor Adaptor Flange F1

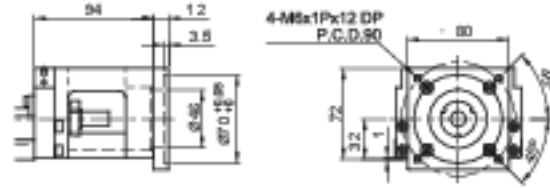

Motor Adaptor Flange F4

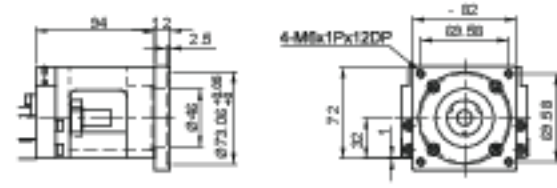

Motor Adaptor Flange F2

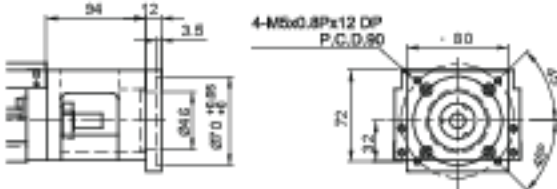

Motor Housing H0

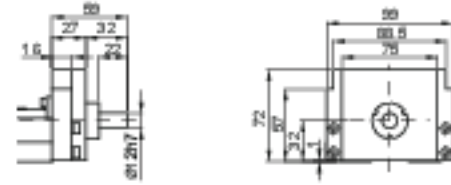

KKP130

Motor Housing F0



Motor Adaptor Flange F3

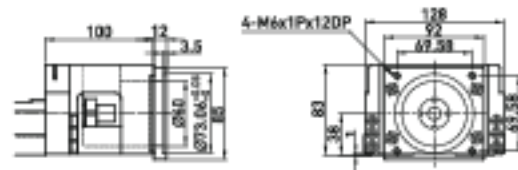

Motor Adaptor Flange F1



Motor Adaptor Flange F4

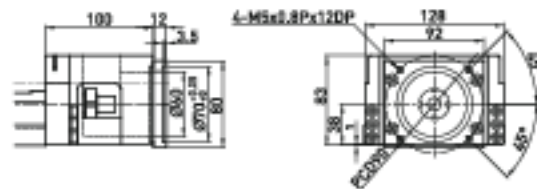

Motor Adaptor Flange F2



Motor Housing H0

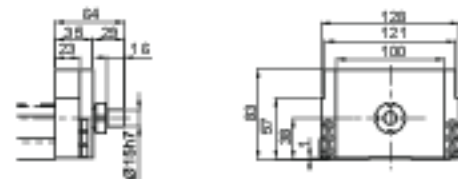

Linear Module

Optional Accessories

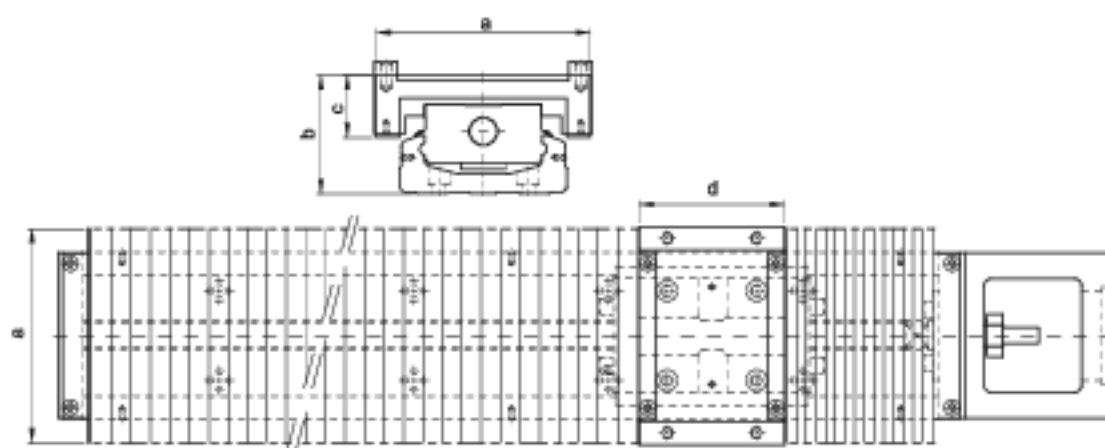

Nominal Width	Rail Length	Stroke	Min.	Max.	a	b	c	d
KKP40	100	35	16	51	60	29.5	19	33
	150	63	27	90				
	200	93	37	130				
KKP50	150	60	21.5	81.5	62	37	19	47
	200	95	29	124				
	250	130	36.5	166.5				
	300	160	46.5	206.5				
KKP60	150	56	16	80	84	45.5	24	54
	200	106	20	126				
	300	166	40	206				
	400	234	56	290				
	500	306	70	376				
	600	366	90	456				
KKP86	340	188	36	224	110	61	32	75
	440	260	50	310				
	540	336	62	398				
	640	408	76	484				
	740	480	90	570				
	940	640	110	750				
KKP100	980	769	58	827	150	73	41	95
	1080	855	65	920				
	1180	945	70	1015				
	1280	1029	78	1107				
	1380	1115	85	1200				
KKP130	980	748	62	810	180	89	53	108
	1180	916	78	994				
	1380	1084	94	1178				
	1680	1346	113	1459				

Linear Module

Switch

Switch rail

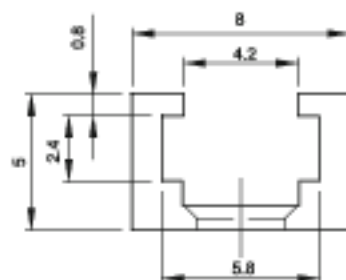

Switch

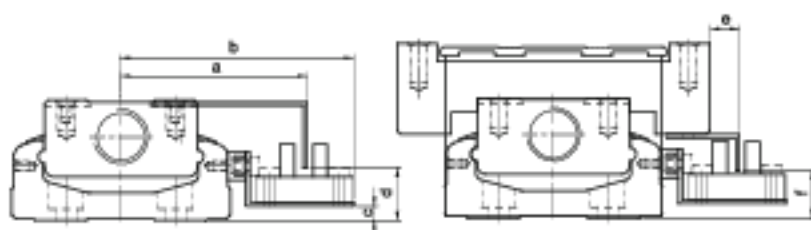

Nominal Width	a	b	c	d	e	f
KKP40	41.5	54.1	0.5	10.8	15.3	12
KKP50	45.5	59	1	10	15	11
KKP60	51	63.8	4	14.5	8	13
KKP86	63.5	76.7	8	18	8	18
KKP100	71	84	10	20	9	20
KKP130	85.5	98.5	14	24	0.5	23

Switch 1: Omron EE-SX671

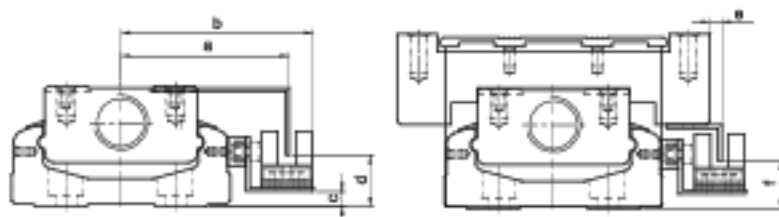

Nominal Width	a	b	c	d	e	f
KKP40	36.5	44.3	1	9.8	10.5	12
KKP50	41.3	48	1	10.5	10.2	11
KKP60	46.2	52.8	4	14	3.2	13
KKP86	59	65.7	8	18	3	18
KKP100	66	73	10	20	4.2	20
KKP130	80.8	87.5	14	23.5	-4.1	23.5

Switch 2: Omron EE-SX674



尺寸	g	h	i	j
KKP40	40	5.5	13.5	5.5
KKP50	39.5	5.7	7	19.5
KKP60	44.5	9	2	9
KKP86	57	13	1	13
KKP100	64.5	15	2.5	15
KKP130	79	19	-6	19

Switch 3, 4: SUNX GX-F12A, SUNX GX-F 12A-P

探索尖端科技, 服务客户, 超越自我。

EXPLORING CUTTING-EDGE TECHNOLOGY, SERVING CUSTOMERS, GOING BEYOND OURSELVES.

真诚 善行 奋进 求索
GOOD FAITH BENEFACTION ENTERPRISING DISCOVERY



ALM Intelligent Technology (Suzhou) Co., Limited

Add: No 1998 Jinfeng south road, Wuzhong district, Suzhou city, China

E-mail: sales@autolinearmotion.com

Tel: 18618962406535

Web: www.autolinearmotion.com